



Integrated Solutions Provider

2021 Results Presentation



1. Key Market trends & Corporate strategy
2. 2021 Business highlights & Results
3. Outlook
4. ANNEX

1. Key Market trends & Corporate strategy

PURPOSE

Consolidate the position as a **solution provider** in the reference markets driven by the trends of **energy transition, digitalization, and sustainability**.

Vision

To be a technological **partner** in a changing world

Mission

To operate in the market of **infrastructure** for the transport of energy, data and material (oil and derivatives, gas, water).

Value proposition

To supply added-value **integrated solutions** for our customers

Strategy

- Innovation
- Integration
- Internationalization



ENERGY AND DATA TRANSPORT



SUSTAINABLE INNOVATION

4.0 industry paradigm

- **Electrification** → zero environmental impact
- **Diagnostic** → highest safety



IMPLEMENTATION ACTIVITIES

Integration of the Sustainability plan in the industrial plan

- **European Taxonomy:** disclosure on eligible KPI
- **Sustainability policy** in line with the strategic guidelines of the **Sustainability plan**
- **QHSE Certifications**
- **Reporting on sustainability** (NFD)

Good ESG scoring in 2021-2022
(Il Sole 24 Ore, AcomeA, La Repubblica, Corriere della Sera & Statista)



STIMULUS PACKAGE

Generate positive impacts from the main stimulus packages in the key countries where the Group operates

- **Digitalization** of products and processes across BUs
- **Sustainable mobility** (rail..)
- **Interconnected grids** (Telecom, smart grids..)

Sustainability as key strategic driver

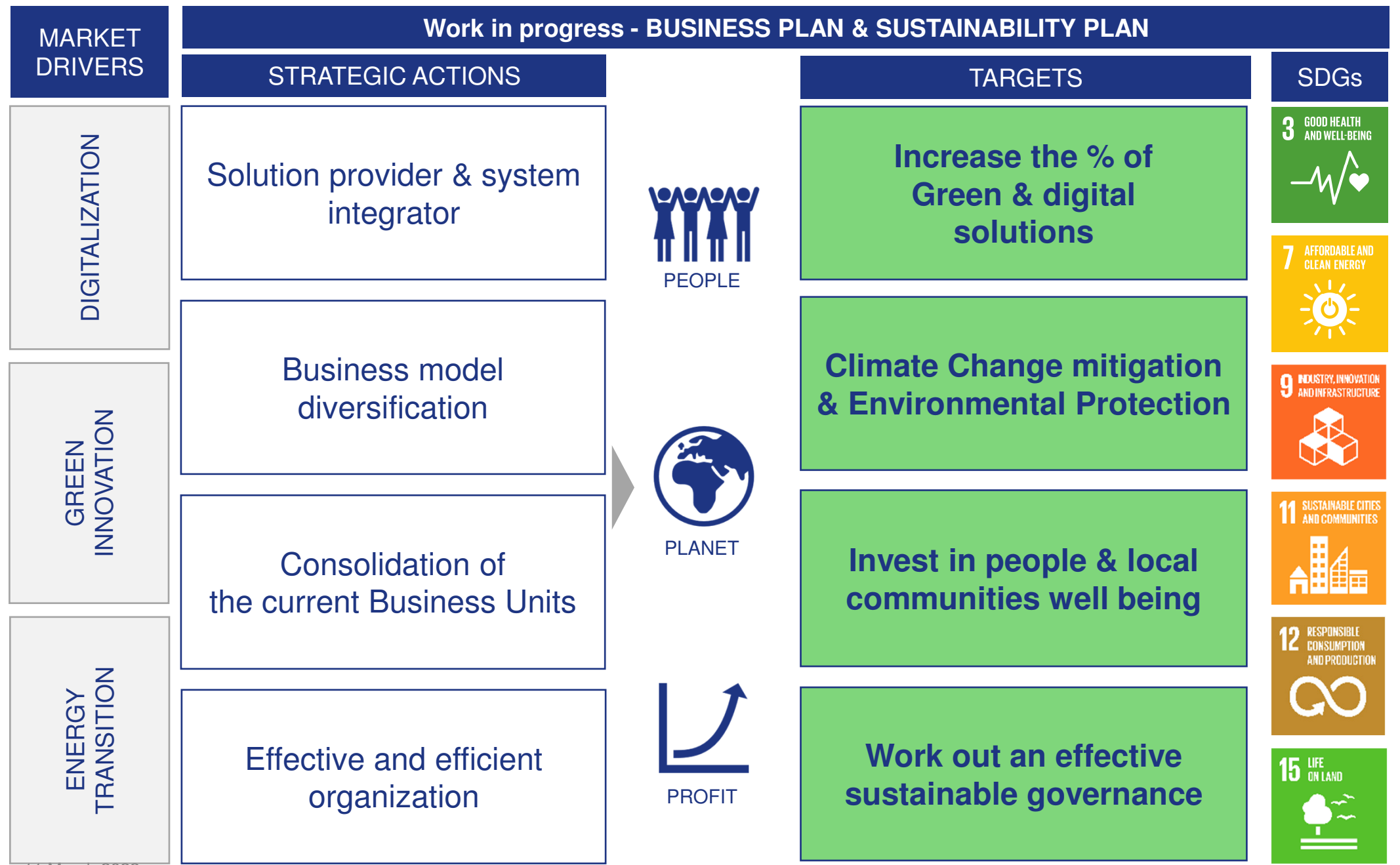

ANNEX I – Climate mitigation

3.Manufacturing

- 3.1 - Manufacture of renewable energy technologies
- 3.3 - Manufacture of low carbon technologies for transport
- 3.6 - Manufacture of other low carbon technologies

2021 is the first year of application of the European Taxonomy. For this reason, the below findings are based on currently available information, which may be subject to future revisions also based on the evolution of the legislation.

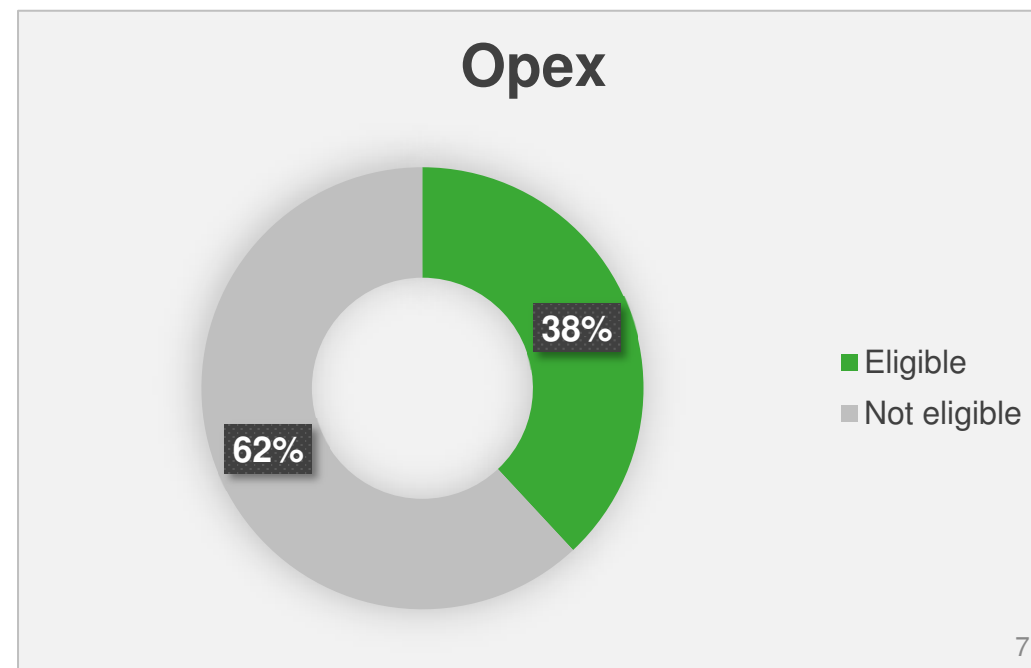
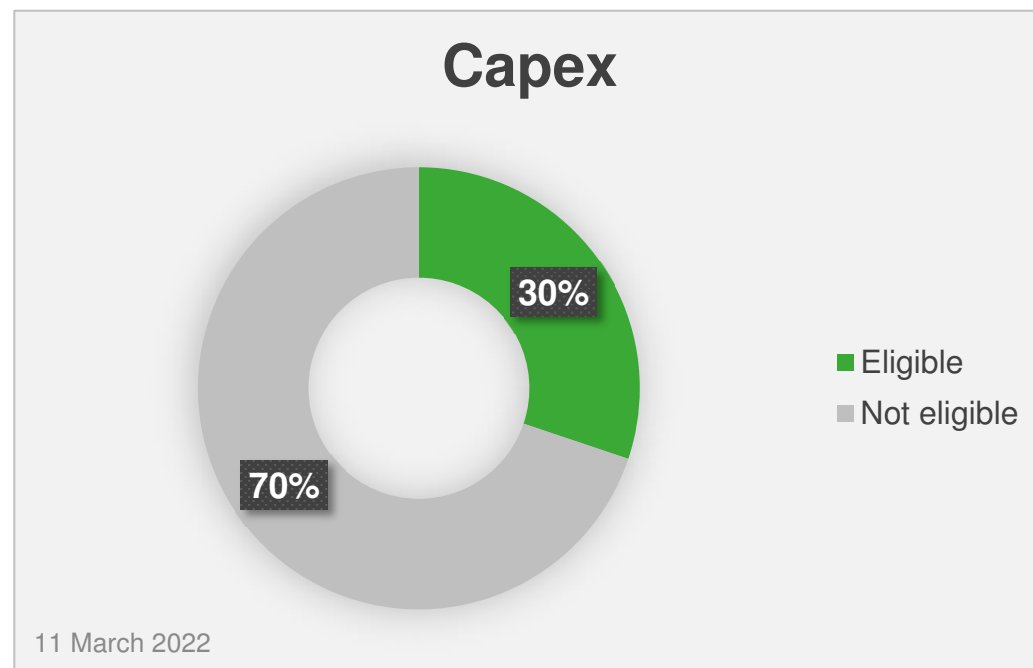
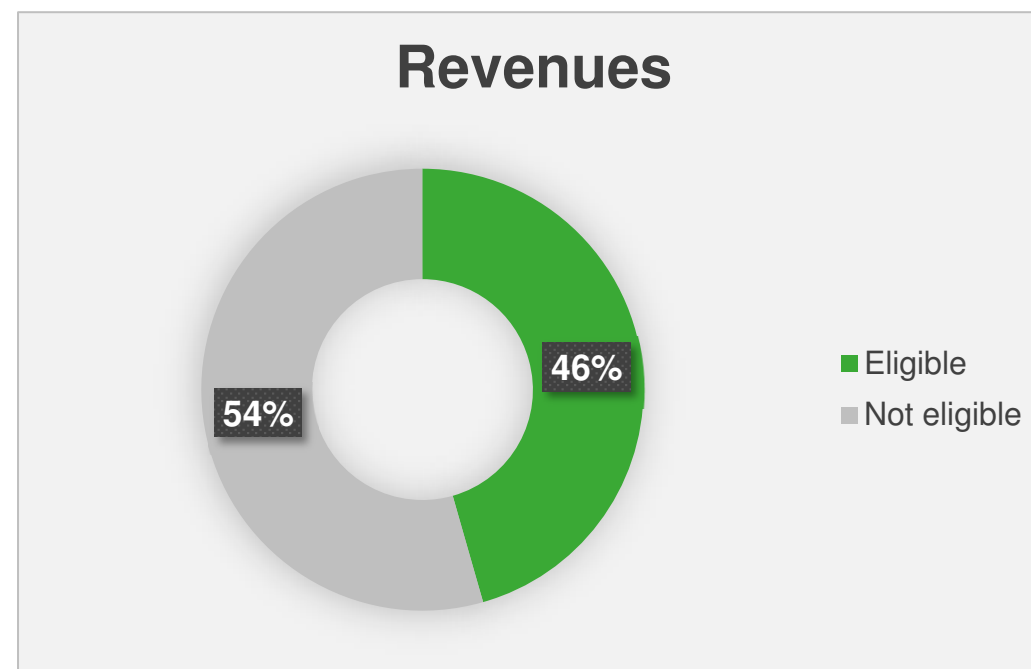

Sustainability as key strategic driver

PRIORITY TOPICS	TASKS (in progress or delivered)
Ethic and sustainable governance	<ul style="list-style-type: none">▪ Gap analysis on the TCDF (Task Force on Climate-related Financial Disclosures) recommendations▪ Strengthen of the sustainability team in order to properly face the increasing opportunities
Green & digital solutions	<ul style="list-style-type: none">▪ Sizing the businesses that are associated with environmentally sustainable economic activities in compliance with the European Taxonomy Regulation. Disclosure of the proportion of turnover, capital expenditures (capex) and operational expenditures (opex) that are eligible for the Taxonomy.▪ Priority to green innovation and actions to meet the Technical screening criteria of the EU Taxonomy Regulation
Climate Change and environmental protection	<ul style="list-style-type: none">▪ Sharing the ESG commitment with major suppliers▪ Actions to correctly manage the use of resources, promoting the reduction of direct and indirect environmental impacts
Development of local communities and areas, enhancement and protection of people	<ul style="list-style-type: none">▪ Several initiatives in the field of the WHP Project (Workplace Health Promotion)▪ Charity initiatives for local communities and non-profit organizations▪ Continuous training program for the development of skills and competences and professional growth of employees

BUSINESS KEY FACTS

- **Sustainability:** new solutions and systems have been developed to make digging and laying more respectful
- **Communities:** Tesmec is committed to work with local communities to improve the digitalisation and connectivity level



First TRT for GreenPose handed to OTE Engineering. The machine was immediately put to work with satisfying results



Gandino digitalization project brought Tesmec technology to the local community, showcasing the ultimate developments for mapping and fiber



New Marais MTR430 saw the light and immediately was put at work in France. It represents a step forward in Marais range development



Mining applications are in continuous improvement. A range of new materials like pozzolan are now being mined with Surface Miners

BUSINESS KEY FACTS

- **Key Markets: Australia & US**
- **Closing of important R&D projects**
- **Good prospects for 2022**



Push on Australian Markets related to big interconnections projects. Important order acquisition at the end of the Q4

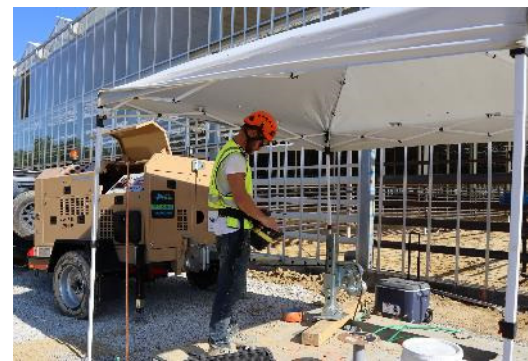

First signs of recovery on US market, good results on second half 2021



Closing of several custom projects for Italian and US markets (puller tensioner PT4800, puller PL1950)



Important order acquisition for 2022 with a significant backlog

BUSINESS KEY FACTS

- **Completion of strategic R&D projects**
- **Acceleration in the Substation Automation business**
- **Significant renewal and expansion of business network**



Back to live exhibition (Enlit 2021 - Milan) to share our latest technologies and consolidate brand identity



Positive market results in Transmission and Distribution segments despite of critical supply chain

CARBON FOOTPRINT



Business focus on cyber-security and sustainability (new Carbon Footprint products certified)



Strategic acceleration in the Substation Automation segment

BUSINESS KEY FACTS

- **Tesmec grows on the international railway market: Czeck Republic and Israel**
- **Strategic event to present innovative technologies**
- **Added value technologies development: from Railway to Civil & Underground diagnostic inspection**



International Growth

Strategic importance for the Group in **the catenary stringing field in Countries that give priority to quality and innovative technologies.**

- Tesmec **enters** the railway business in **Israel**, a market with interesting growth opportunities.
- **Consolidation** of Tesmec position in the **Czeck Rep.**



Reality rooted in a territory rich in excellence & skills

Highlight the strong link between the Group, the local community, universities and local institutions, **supporting the railway sector: DIGITAL INNOVABILITY.**

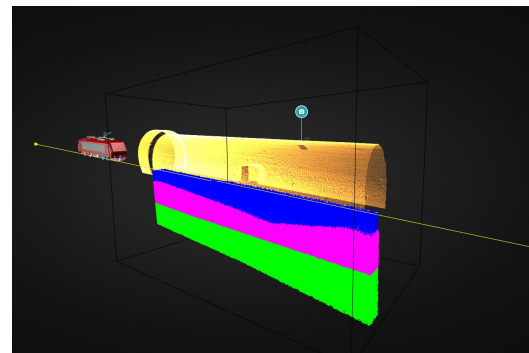

New vision inspection systems (drones, radar)

Tesmec R&D future projects through its **innovative pole and R&D center:**

- New vision inspection systems **starting from railway to other infrastructure diagnostic applications.**

2.

2021 Business highlights & Results

2021 Closing

GROUP (€ mln)	2021	2020	Delta vs.20
REVENUES (1)	194,3	170,6	13,9%
EBITDA (2) (3)	28,1	21,0	34,1%
% on Revenues	14,5%	12,3%	
EBIT (4)	5,7	(0,9)	
% on Revenues	2,9%	-0,5%	
Differences in Exchange (5)	3,2	(3,6)	
% on Revenues	1,7%	-2,1%	
PROFIT (LOSS) BEFORE TAX	2,7	(9,0)	
% on Revenues	1,4%	-5,3%	
NET INCOME/(LOSS)	1,2	(6,8)	
% on Revenues	0,6%	-4,0%	

GROUP (€ mln)	2021	2020	Delta vs.20
NFP ante IFRS 16	96,5	82,3	-17,2%
NFP post IFRS 16	121,0	104,4	-15,9%

- (1) **Revenues: increase respect the 2020** although impacted by the supply chain and logistic criticalities
- (2) **EBITDA: positive impact** by the Energy and Railways business to compensate the negative performance of USA & AUS markets in TRS business
- (3) **EBITDA: improve** thanks to the **recurring activities with high margin** and impacted by the **utilities** and **raw materials** cost increase, reversed on the price lists of products and services, but not already reversed on the medium-long term contract with the public administration, for which the negotiations are still ongoing.
- (4) **Impacted** by 4service's fleet depreciation
- (5) **The exchange differences are positive (USD & related currencies)**, compared to the closing of 2020.
- (6) **NFP: impacted by the NWC variation, increased** in order to face the tensions in the supplying and shipment/freight activities and to face the continuing inflation.

2021 Closing – Business Breakdown (€ mln)

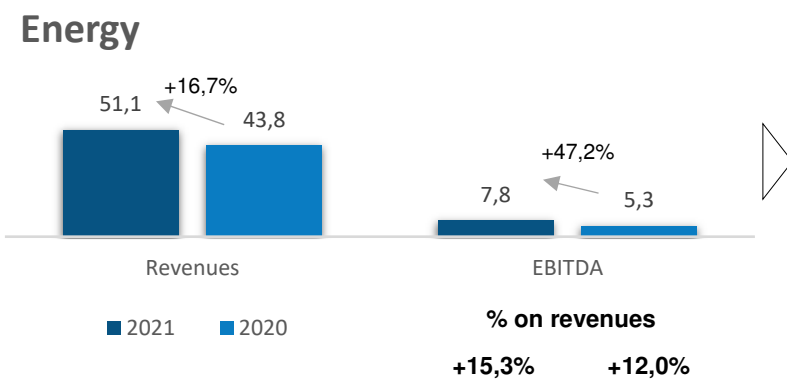

> **Rebound** compared to 2020 lead by the **Energy industry trend**

> **EBITDA:** impacted by **Energy Automation performance** and the improvement of the **Stringing segment** after years of product **range transition**, although consider the increase in cost of material and utilities.

> The **confirmed order backlog** was **Euro 98,9 million** of which **Euro 80,7 million** from the **Energy Automation**

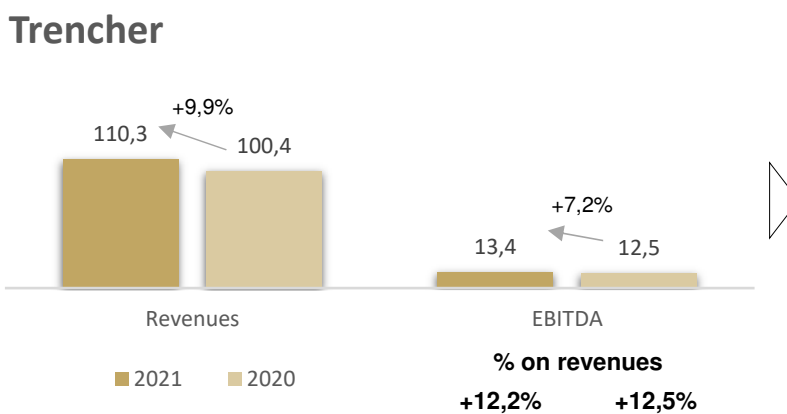

> **Back to the sales** but slowdown of the USA market and **delay** in the deliveries to due the supply chain worldwide critical situation (**freight cost, lead time & price variation** of the raw materials). Growth recorded in the renewable energies & telecom sector, with an increase in the share of sustainable and recurring turnover.

> **EBITDA** impacted by the Australian performance and the gap in the sales of the USA market

> The **confirmed order backlog** was **Euro 75,4 million**

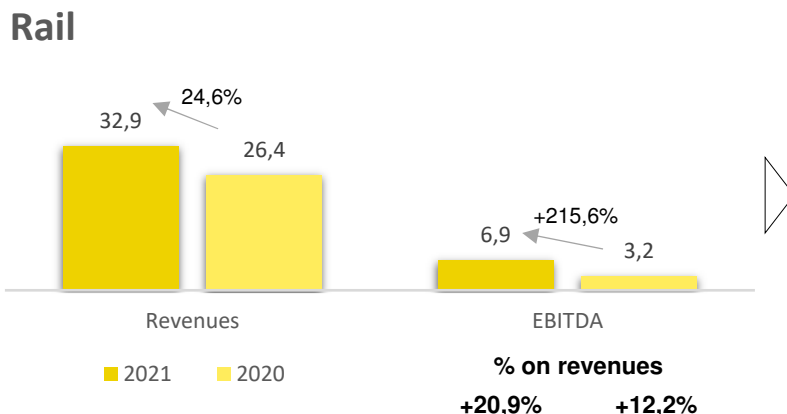

> Less impacted by the lock down in the 2020. The revenues are related to the medium-long term contracts with an increase due to a better products mix related to the diagnostic and energy transaction system

> **EBITDA:** **increased** respect the 2020 due to the better mix of products

> The **confirmed order backlog** was **Euro 109,9 million**, delays in the award of new contracts



(1) Of which **Euro 80,7 million by Energy Automation** and new opportunities in hi-tech content business

(2) **Acquisition** of new orders during the last quarter of the year

2021 Revenues: sales spread over different geographical area

REVENUE BY GEOGRAPHY 2021

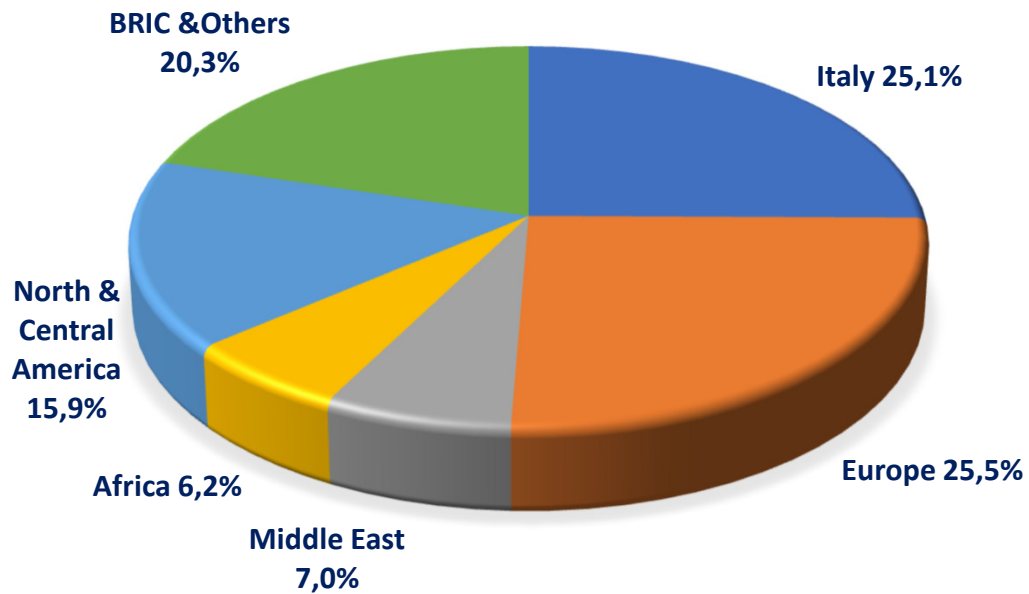

REVENUE BY GEOGRAPHY 2020

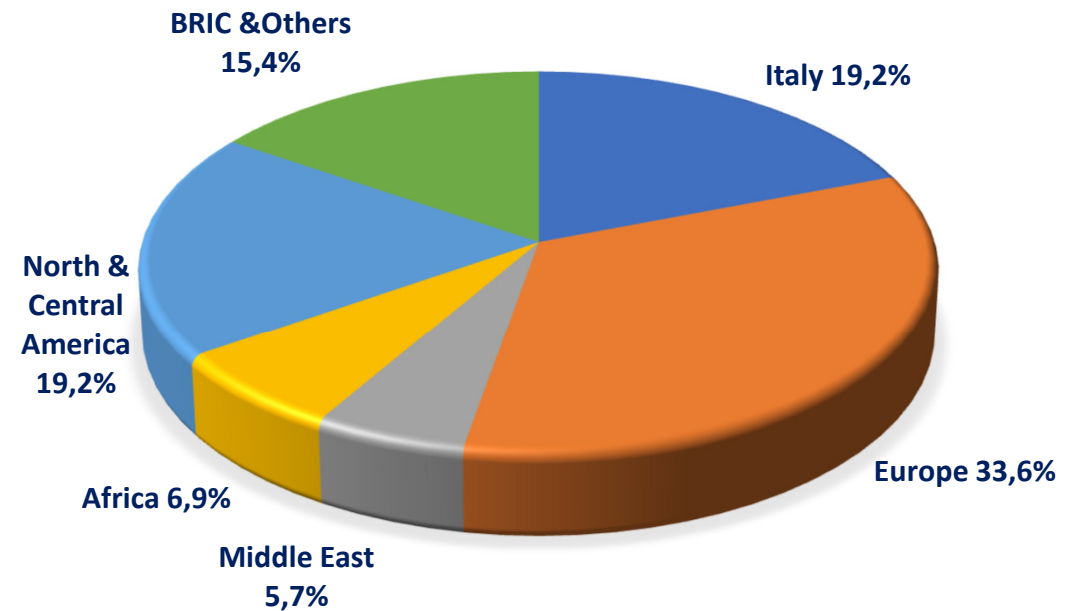

- **ITALY:** railway & energy automation impact
- **USA&EU:** trencher and railway impact
- **BRICS:** trencher and stringing impact

2021 Revenues: recurring vs non recurring

REVENUES RECURRING VS NON RECURRING 2021

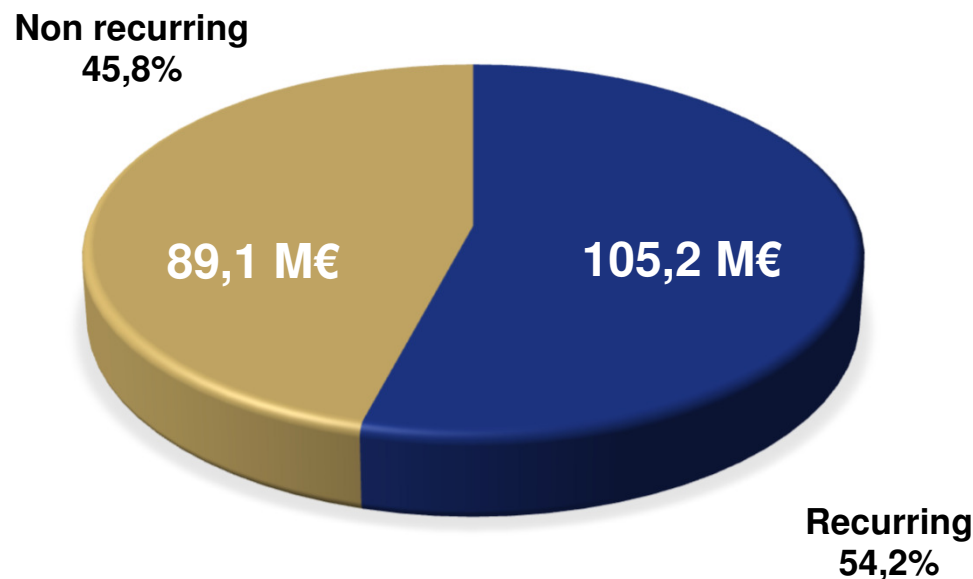

REVENUES RECURRING VS NON RECURRING 2020

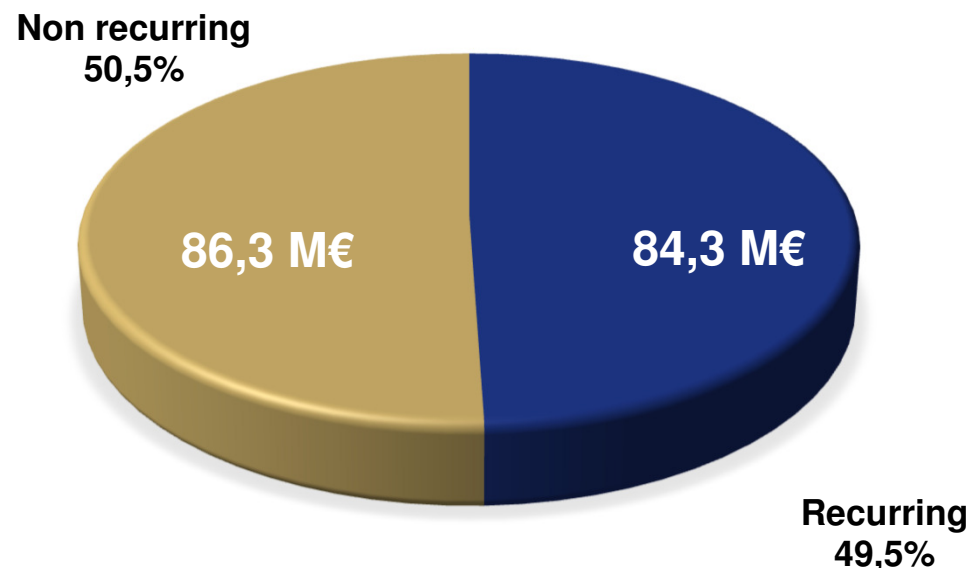

- Recurring: Rental, Projects, Spare Parts, Services (maintenance, revamping & refurbishing, consulting & training), long term backlog (Automation & Rail)
- Non recurring: Sales of goods
- Confirmed recurring & back to sales after the impact of the covid-19 in the 2020

2021 EBITDA

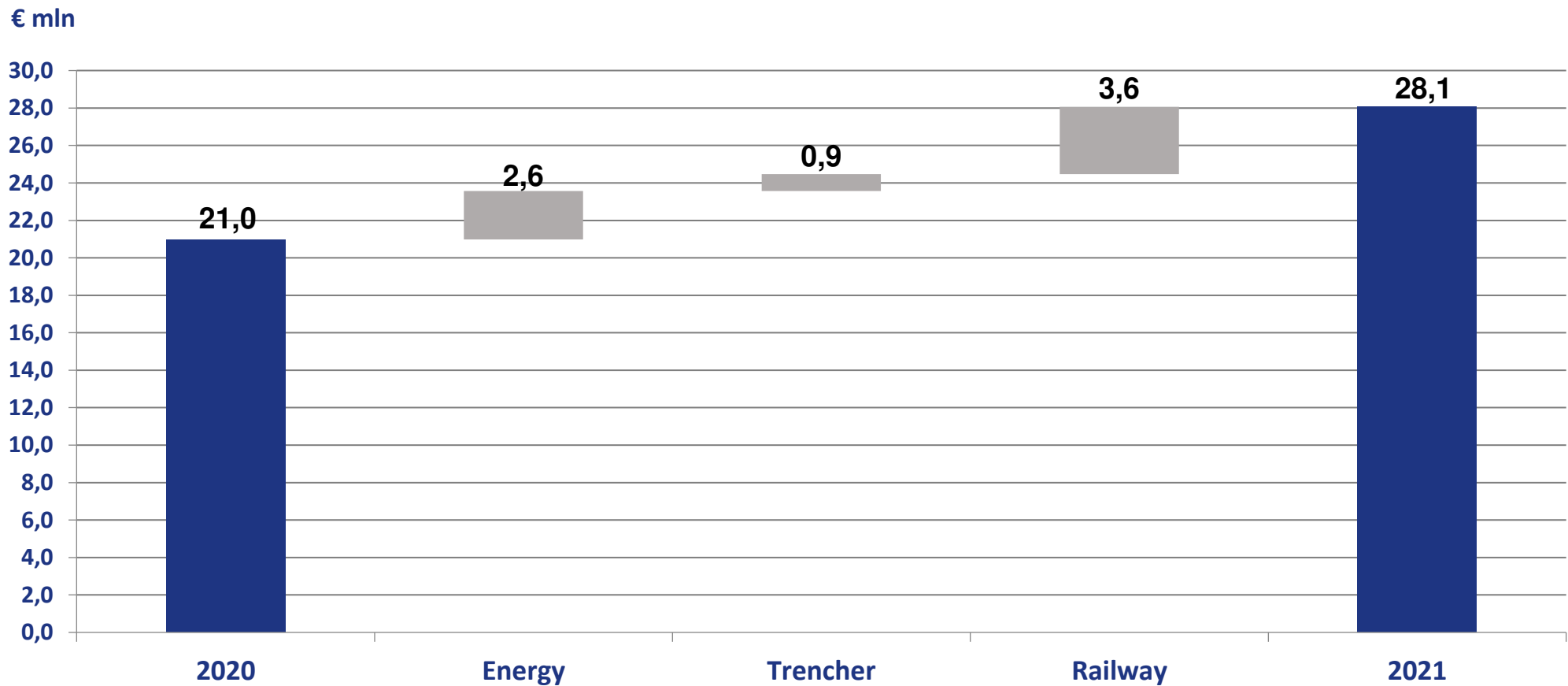

2021 Financial Results

Financial Information (€ mln)	2021	2020
Net Working Capital	77,8	64,3
Non Current assets	79,6	76,7
Right of use - IFRS 16/IAS 17	23,4	22,8
Other Long Term assets/liabilities	12,9	10,0
Net Invested Capital	193,7	173,8
Net Financial Indebtness	96,6	82,3
Lease liability - IFRS 16/IAS 17	24,5	22,1
Equity	72,6	69,4
Total Sources of Financing	193,7	173,8

2020

Increase of the NWC due to stock

2021

2021 Working Capital evolution

€ mln

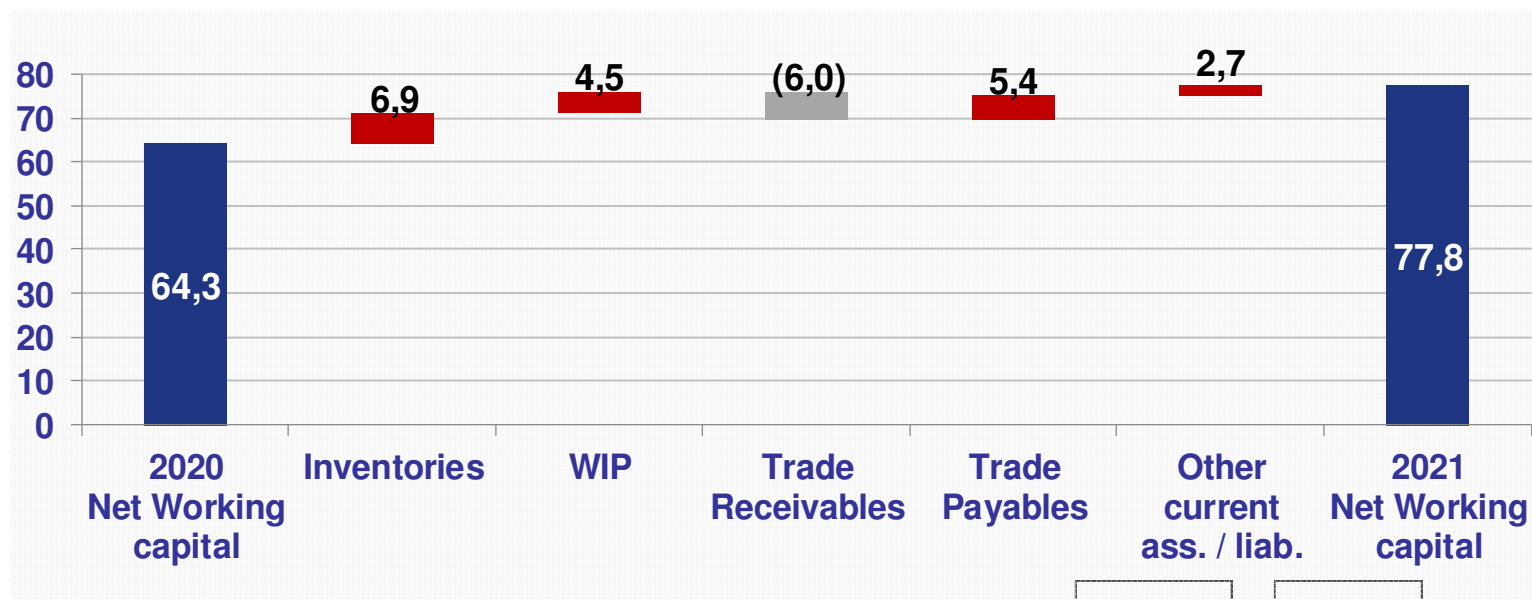

€ Mln	2021.FY	2020.FY	2021.FY	2020.FY
Trade Receivables	54,4	60,4	101	127
Inventories	81,3	74,4	151	157
Work in progress contracts	15,7	11,2	29	24
Trade Payables	(56,0)	(61,4)	-104	-129
Other Current Assets/(Liabilities)	(17,6)	(20,3)	-33	-43
Net Working Capital	77,8	64,3		

2020
€ 64,3 mln

Increase of NWC due to the supplying and logistic tensions, to support the sales of the next year

2021
€ 77,8 mln

2021 Net Financial Position Evolution

€ mln

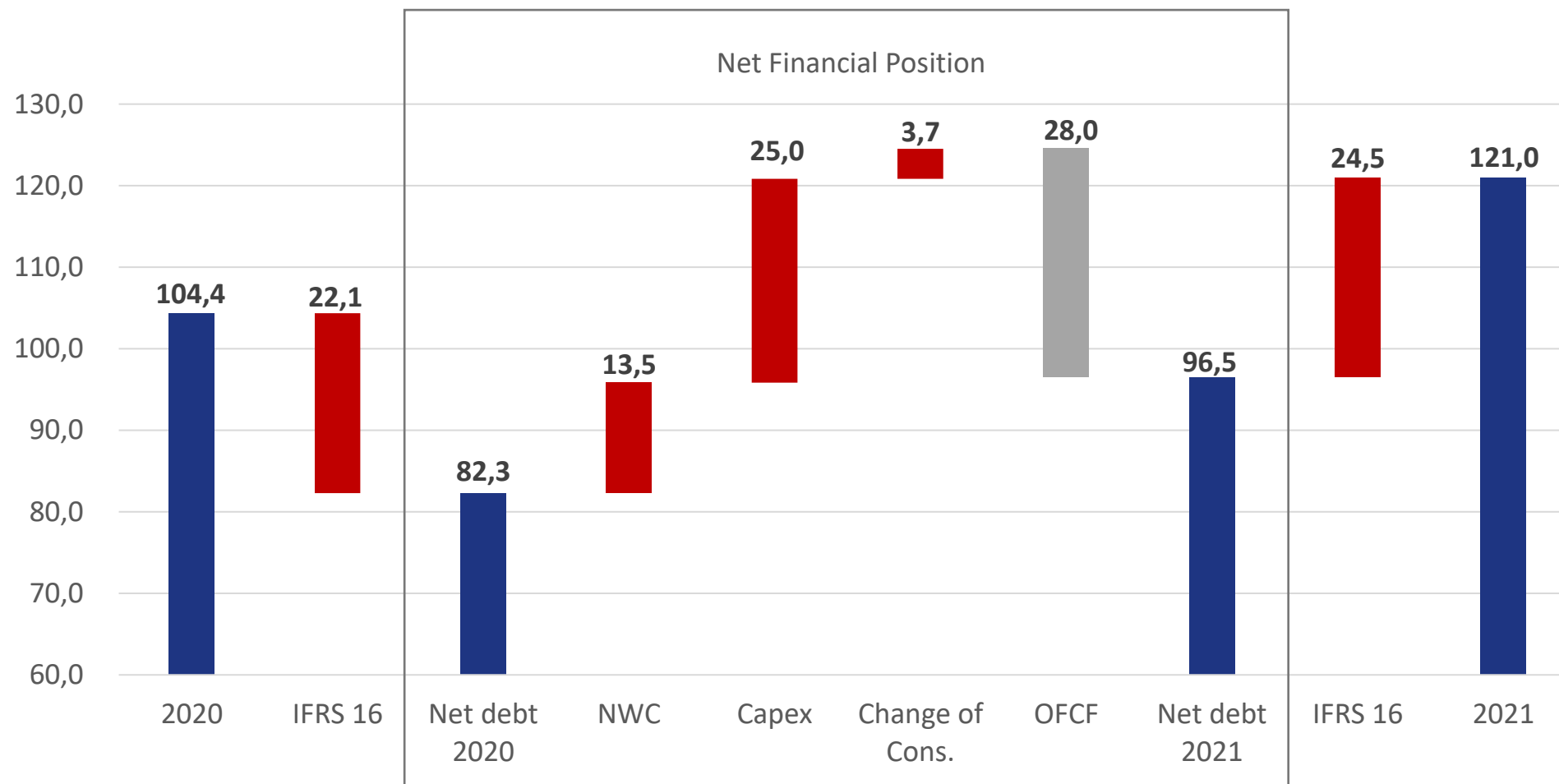

2020

**Impacted by the increase of NWC, mitigated by operating cash generation.
Capex impacted by the implementation of the new ERP. Change of consolidation include the acquisition of 49% of Saudi Tesmec**

2021

2021 Net Financial Position Evolution

NET FINANCIAL POSITION

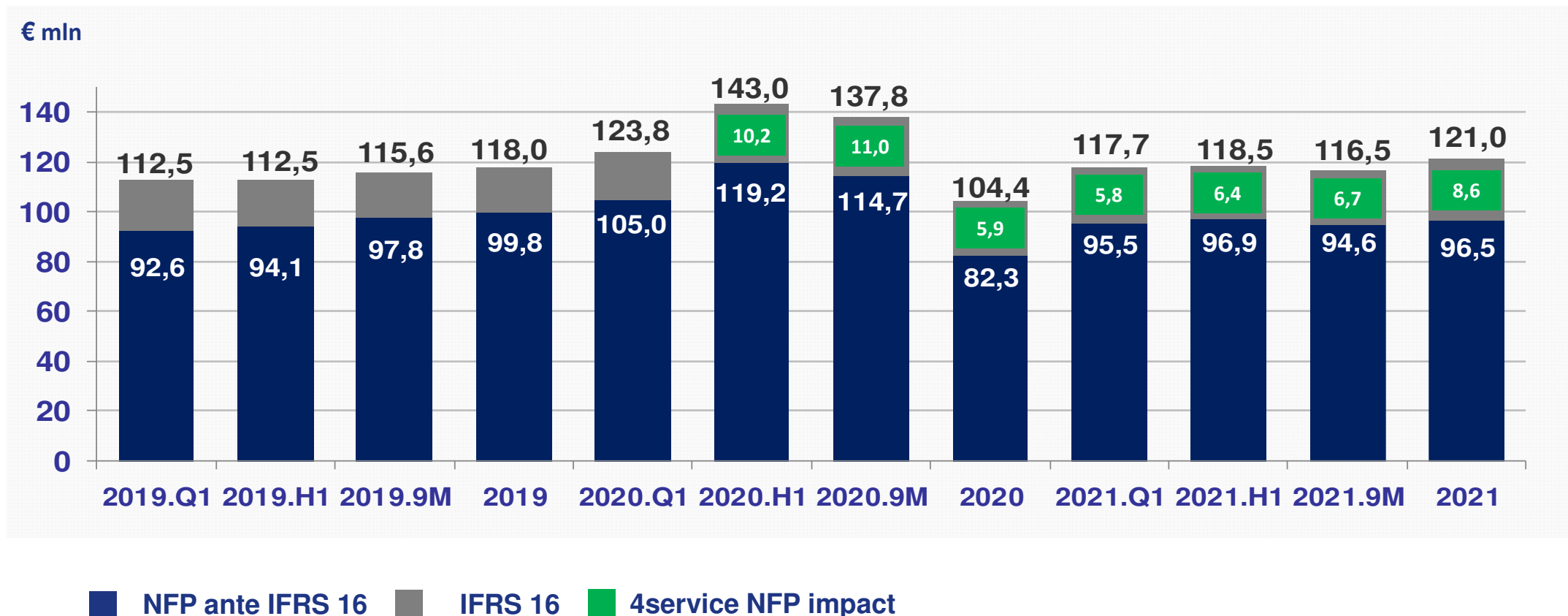

From 1st January 2019, the new IFRS 16 has been introduced, the impact in term of NFP is around 24,5 M€, otherwise the NFP would have been around 96,5. Since April 2020 the NFP included the financial debt from the acquisition of 4service around 8,6 M€ (of which 8,1 M€ related to the IFRS 16) at 31 December 2021.

3.

Outlook

KEY POINTS

- **Strategic positioning** in key and growing sectors: telecommunication, smart grids, renewable energy, mining, railway
- Expected positive outlook driven by "**Green Deal**" on key markets such as US, Western Europe & Australia

SMART GRID market
CAGR **11.8%** (2020-2025)



WORLD RAILWAY market
CAGR **2.3%** (2020-2025)



TELECOM market
CAGR **5%** (2020-2025)



RENEWABLE ENERGY market
CAGR **6.1%** (2018-2025)



MACRO ECONOMIC SCENARIO

- **Inflation** speed up
 - Increase of raw materials & commodities costs and freight & logistic costs
 - Increase in utilities
- Shortage of materials, longer delivery time
- Momentum of uncertain, mainly related to the situation in Russia-Ukraine but partially compensate by the booming of specific geographic areas
- Positive impact of **recovery plans** on reference markets of the Group:
 - **ITALY**: strong push to business thanks to incentives, especially in Southern Italy
 - **EUROPE**: important stimulus packages to boost the recovery
 - **USA**: focus on Clean Energy and big high speed railway projects
- Strong impact of **sustainable projects** and **climate change issue** in the development plans worldwide

MAIN ACTIONS to support the growth

- **Reverse** the inflation on selling price of products and services, negotiating the review of the medium-long contracts with public administration and with cost efficiencies
- Rationalization and **better cost/revenues ratio**
- Cover the criticalities regarding the exchange rate
- Face the conjunctural situation in Russia-Ukraine, focalizing on other country with high incoming opportunities (i.e.: Middles East, U.S.A.)
- Focus on strategic sectors driven by the **energy transition trend**
- Green **innovation** and process **digitalization**

OUTLOOK 2022

- **Detection and mapping revolution**
- **New models and solutions for fiber, cables and mining**
- **Electrification of urban digging solutions**



Drone, mobile warehouse, digital platforms for project management and radars are developing a new market for the group

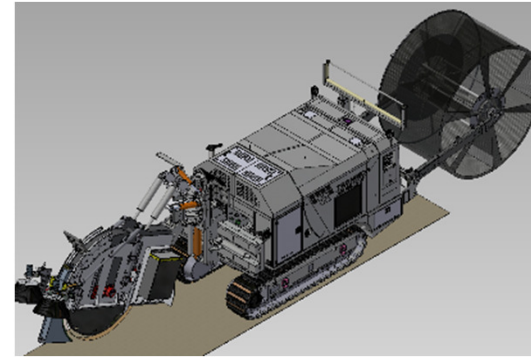

New Multicut 400 is going to hit the market by H1 2022. European fiber and cable laying markets are the main target for this new solution



Direct Drive digging solution has undergone tests and is likely going to represent a powerful alternative to enter soft and elastic soils mining



Electrification path is being undertaken. A first prototype will be engineered to make urban works emissionless

OUTLOOK 2022

- Important re-lining & cable laying projects
- R&D focus on new methodologies & green solutions
- Supply Chain impact



Focus on re-lining & transmission projects in Middle East with important orders acquisition on Q1



Push on German corridors with special solutions dedicated to underground transmission lines



Development of a special light solution for reconductoring projects, enlargement of the zero emissions machines range for distribution.



Supply Chain disruption with a critical impact on delivery & warehouse management (push on standard solutions)

OUTLOOK 2022

- Consolidation of existing market
- Focus on market expansion with new business models
- New organization of service & after-sales activities



Completion of product portfolio and promotion of innovative solutions to develop new market channels



Consolidation of existing market with accurate sales initiatives and participation to new and on-going tenders



Reinforcement of service activities to support business growth and generate new revenue streams



Growth strategy in the Substation Automation market to increase a business's market share



" Digital and Sustainable company "

Technologies for a safe, efficient and sustainable railway and civil infrastructure



Commitment to make the railway infrastructure world even greener

R&D projects focused on electric solutions according to sustainable mobility trends: **Hybrid & Full Electric, Bimodal Vehicles.**

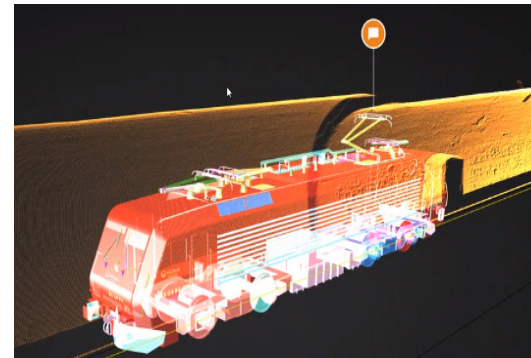

Digital technologies for the diagnostic of infrastructures

Systems, vehicles, integrated solutions for **railway and civil diagnostic inspection** to improve safety and ensuring reliable service.

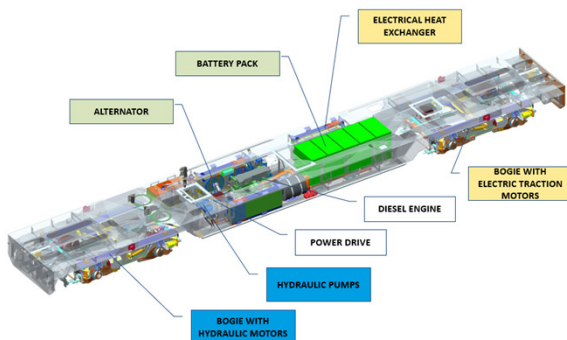

Sustainable transmission power units

100% reduction of emissions for a **greener complete value chain:**

- ✓ Installation
- ✓ maintenance
- ✓ diagnostic

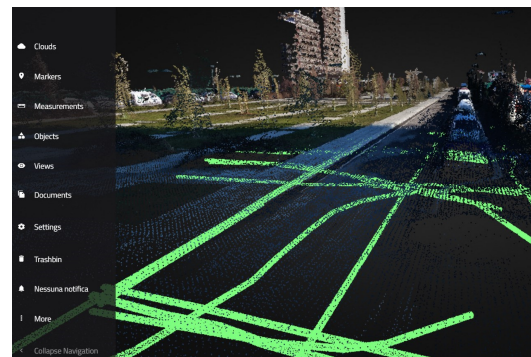

From Rail to Civil & Underground diagnostic

Implementation of Rail R&D systems to **underground applications: Mobile Workshop.**

Integrated Artificial Intelligent centralized **platform** to predict maintenance needs and for optimal efficiency.

2020-2023 Business Plan guidelines

Although the conjunctural situation of global uncertainty, there aren't criticalities on the guidelines of the plan. The outlook 2022 will be shared together with the results of the first Quarter of 2022 looking the evolution of the actual situation.

	2019pf	2020pf	2021	2023 Confirmed
TURNOVER	199.6 M€	172.8 M€	194.3 M€	275 ~ 290 M€ cagr ₁₉₋₂₃ : 8.5%~10.0%
			<ul style="list-style-type: none"> >> Significant performance of the Energy Automation segment; Stringing segment back to historical performances >> Focus on recurring revenues (rental & services) >> Growth in each business line 	
EBITDA	30,0 M€	22,9 M€	28,1 M€	53 ~ 58 M€ cagr ₁₉₋₂₃ : 17.0%~18.0%
			<ul style="list-style-type: none"> >> Better mix of products & systems, premium price policy, impact of new high margin activities such as rental and hi-tech solutions >> Rationalization and standardization of the products portfolio >> Broadly stable fixed costs 	
NFP	130,0 M€	104,4 M€	121,0 M€	improvement
			<ul style="list-style-type: none"> >> Net working capital improvement and efficiency actions on inventory >> Optimization of credit management policies >> 2020-2023: Cumulated Capex in 4 years 60M€, progressive reduction to 5% of the CAPEX/Revenues 	

The impact of inflation & supply chain criticalities were not included in the business plan 2020-2023

4.

ANNEX

Summary 2021 Profit & Loss statement - Appendix A

Profit & Loss Account (Euro mln)	2021	2020	Delta vs 2020	Delta %
Net Revenues	194,3	170,7	23,6	13,8%
Raw materials costs (-)	(78,6)	(77,4)	(1,1)	1,5%
Cost for services (-)	(37,7)	(30,2)	(7,6)	25,1%
Personnel Costs (-)	(56,0)	(48,5)	(7,5)	15,4%
Other operating revenues/costs (+/-)	(3,3)	0,2	(3,5)	-1680,6%
Non recurring revenues/costs (+/-)	-	0,0	0,0	na
Portion of gain/(losses) from equity investments evaluated using the equity method	1,4	0,5	0,9	171,1%
Capitalized R&D expenses	8,1	5,8	2,3	39,4%
Total operating costs	(166,2)	(149,6)	(16,6)	11,1%
<i>% on Net Revenues</i>	<i>(85,5%)</i>	<i>(88%)</i>		
EBITDA	28,1	21,1	7,1	68,1%
<i>% on Net Revenues</i>	<i>14,5%</i>	<i>12%</i>		
Depreciation, amortization (-)	(22,4)	(21,8)	(0,6)	2,8%
EBIT	5,7	(0,8)	6,5	-831,0%
<i>% on Net Revenues</i>	<i>2,9%</i>	<i>0%</i>		
Net Financial Income/Expenses (+/-)	(3,0)	(8,2)	5,2	-63,5%
Taxes (-)	(1,5)	2,2	(3,7)	-167,6%
Minorities	0,0	(0)	0,0	
Group Net Income (Loss)	1,2	(6,8)	8,0	n/a
<i>% on Net Revenues</i>	<i>0,6%</i>	<i>-4,0%</i>		

Summary 2021 Balance Sheet - Appendix B

Balance Sheet (€ mln)	2021	2020
Inventory	81,3	74,4
Work in progress contracts	15,7	11,2
Accounts receivable	54,4	60,4
Accounts payable (-)	(56,0)	(61,4)
Op. working capital	95,4	84,6
Other current assets (liabilities)	(17,6)	(20,3)
Net working capital	77,8	64,3
Tangible assets	47,6	49,8
Right of use - IFRS 16/IAS 17	23,4	22,8
Intangible assets	23,9	22,5
Financial assets	8,1	4,4
Fixed assets	102,9	99,5
Net long term liabilities	12,9	10,0
Net invested capital	193,7	173,8
Cash & near cash items (-)	(50,2)	(70,4)
Short term financial assets (-)	(16,8)	(13,8)
Lease liability - IFRS 16/IAS 17	24,5	22,1
Short term borrowing	59,5	85,8
Medium-long term borrowing	104,0	80,7
Net financial position	121,0	104,4
Equity	72,6	69,4
Funds	193,7	173,8

Disclaimer

The manager responsible for the preparation of the corporate accounting documents, Marco Paredi, declares, pursuant to article 154-bis, paragraph 2, of Legislative Decree No. 58/1998 ("Consolidated Law on Finance") that the information contained in this press release corresponds to the document results, books and accounting records. Note that in this press release, in addition to financial indicators required by IFRS, there are also some alternative performance indicators (e.g. EBITDA) in order to allow a better understanding of the economic and financial management. These indicators are calculated according to the usual market practice.

This press release contains some forward looking statements that reflect the current opinion of the Tesmec Group management on future events and financial and operational results of the Company and of its subsidiaries, as well as other aspects of the Group's activities and strategies. These forward looking statements are based on current expectations and assessments of the Tesmec Group regarding future events, as well as on the Group's intentions and beliefs. Considering that these forward looking statements are subject to risk and uncertainty, the actual future results may considerably differ from what is indicated in the above forward looking statements as these differences may arise from several factors, many of which lie beyond the Tesmec Group's ability to accurately check and estimate them. Amongst these - including but not limited to - there are potential changes in the regulatory framework, future developments in the market, price fluctuations and other risks. Therefore, the reader is asked to not fully rely on the content of the forecasts provided as the final results could significantly differ from those contained in these forecasts for the reasons indicated above. They have been included only with reference up to the date of the above-mentioned press release. The prospective data are, in fact, forecasts or strategic targets established within the corporate planning.

The Tesmec Group does not assume any obligation to publicly disclose updates or amendments of the forecasts included regarding events or future circumstances that occur after the date of the above-mentioned press release. The information contained in this press release is not meant to provide a thorough analysis and has not been independently verified by any third party. This press release does not constitute a recommendation for investment on the Company's financial instruments. Furthermore, this press release does not constitute an offer of sale or an invitation to purchase financial instruments issued by the Company or by its subsidiaries.



www.tesmec.com