

COIMARES

H1 2020 RESULTS
BACK TO THE OFFICE

July 31st, 2020

REAL ESTATE SIIQ

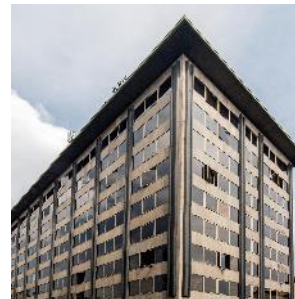

Key Highlights
Manfredi Catella, CEO

Financial Results
Fulvio Di Gilio, CFO

Portfolio & Asset Management
Matteo Ravà, Head of Asset Management

Market Outlook
Gabriele Bonfiglioli, Head of Investments

Closing Remarks
Manfredi Catella, CEO

Appendix



COIMARES

ITALY - UPDATE POST LOCK-DOWN



Mobility across regions in Italy reactivated after 3 months of lock-down (on June 3rd, 2020)

NUMBER OF COVID CASES IN ITALY

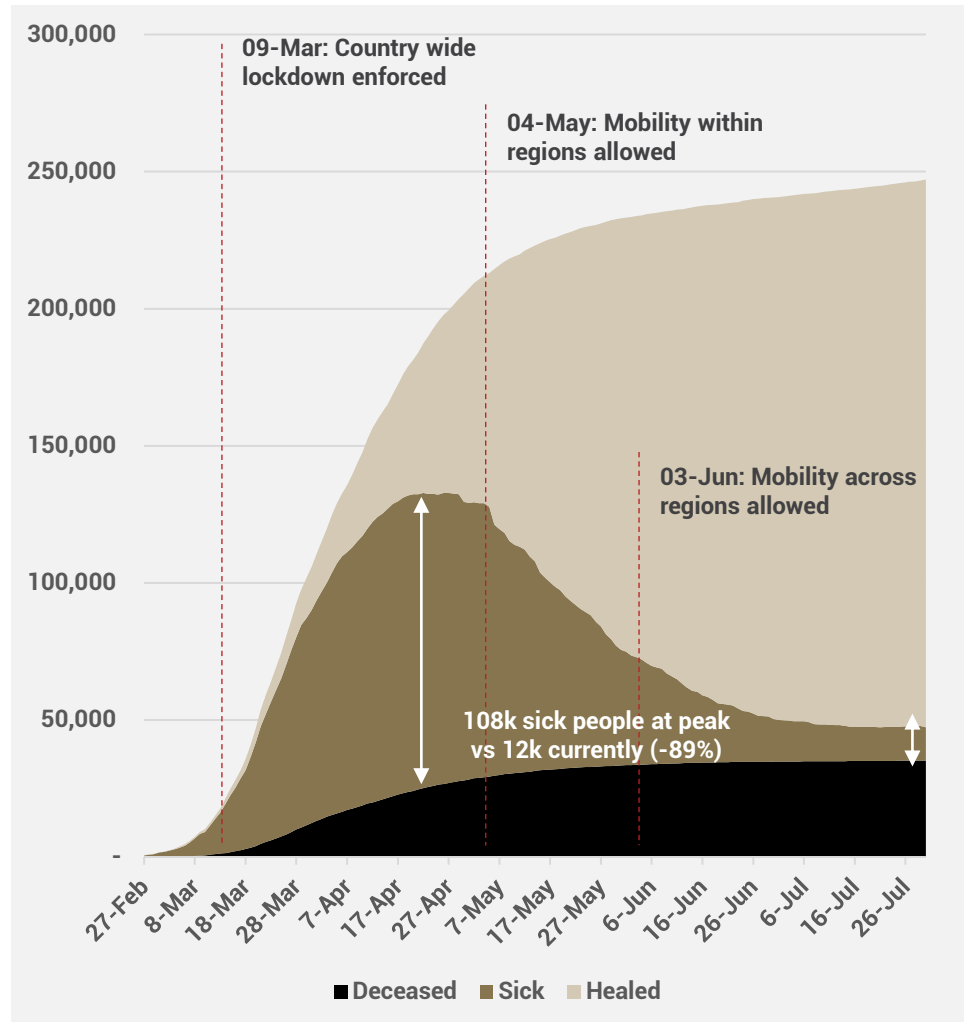

MOBILITY IN ITALY IN 2020 YTD

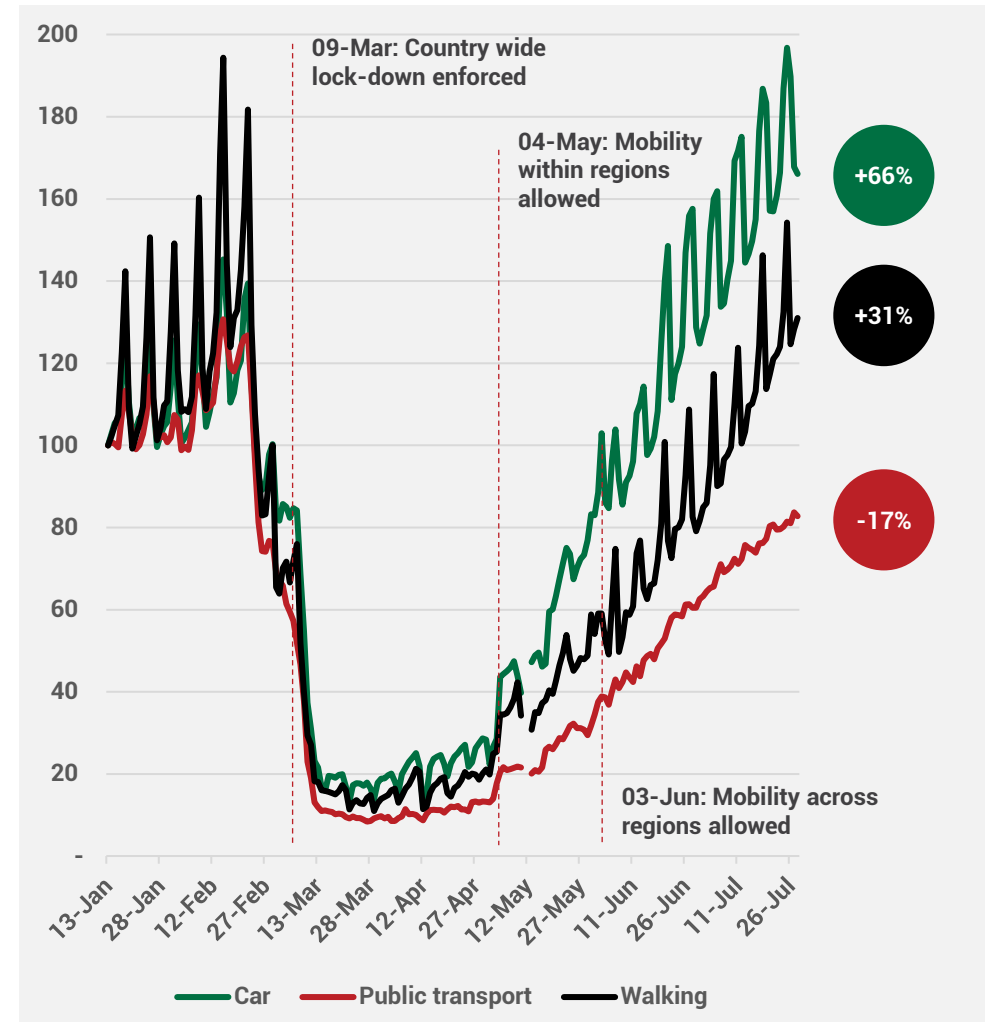

Source: Protezione Civile, Il Sole 24 Ore, Apple

COIMA RES - EXECUTION UPDATE



Coherent execution in line with strategy continued in H1 2020, notwithstanding the COVID-19 crisis

DISPOSAL OF NON STRATEGIC ASSETS

- Closed first tranche of disposal of portfolio of bank branches for €17.2m (9 bank branches)
 - Relates to €23.5m disposal of an 11 bank branches portfolio announced in Nov-19
 - Final tranche (2 bank branches in Milan) worth €6.3m to close in January 2021



BUSINESS CONTINUITY PRESERVED

- Ad-hoc COVID-19 Task Force ensuring business continuity for COIMA and its tenants
 - COIMA working remotely from March to May, back in the office from June (30-50% capacity)
 - Coordination with tenants to help them organising Phase I, Phase II and Phase III



IMPROVED G&A LOAD

- Material improvement in the G&A Load through renegotiation of asset management agreement
 - Asset management fee reduced by 27%, €1.3m of saving per annum
 - CEO foregoes personal remuneration, in line with conduct held since IPO



ANNUAL GENERAL MEETING

- Annual General Meeting held on 11-Jun in compliance with COVID-19 restrictions
 - Dividend for 2019 of €0.30 per share approved
 - Renewed independent Board of Directors with increased gender balance



FURTHER INVESTMENT IN PORTA NUOVA

- COIMA RES to acquire a 10-25% stake in Gioia 22 property
 - In line with strategy of building a portfolio of high quality office properties in Milan
 - Portion of portfolio in Porta Nuova to increase to 54-58% pro-forma (vs 51% currently)



GIOIA 22 - ACQUISITION OVERVIEW



Acquisition of a stake in a highly sustainable Core property in Porta Nuova

ACQUISITION OVERVIEW

Transaction rationale

- Investment in high quality Core property in Porta Nuova
 - Increase the portion of portfolio situated in Porta Nuova to 54-58% (from 51%)

Transaction details

- Acquisition of a 10-25% stake in Gioia 22 property
 - Closing by the end of 2021, subject to pre-let of 75% of surface becoming effective
 - Remaining 25% vacancy being commercialised
 - Transaction values Gioia 22 at €442.1m (€12.3k/sqm capital value vs prime of €18.2k/sqm)

Other industrial features

- Size: 35,800 sqm, 26 floors above ground
- Architects: Pelli Clarke Pelli Architects
- Certifications: NZEB, LEED Platinum, WELL Silver and Cradle to Cradle
- Electricity & Water: 6,000 sqm¹ of photovoltaic panels, deployment of ground water
- Energy reduction in operation: 75% (compared to traditional buildings)
- CO₂ reduction in operation: 2,260 tons p.a.² (vs previous building)
- Demolition of previous tower involved the removal of 200 tons of asbestos
- Opening of public pedestrian area surrounding the property (previously gated area)



Note:

- 1)
- 2)

*Energy produced by the photovoltaic system could be sufficient to satisfy the energy needs of 306 homes
Equivalent to absorption of approximately 10 hectares of forest (4,500 trees)*

Key Highlights
Manfredi Catella, CEO

Financial Results
Fulvio Di Gilio, CFO

Portfolio & Asset Management
Matteo Ravà, Head of Asset Management

Market Outlook
Gabriele Bonfiglioli, Head of Investments

Closing Remarks
Manfredi Catella, CEO

Appendix



COIMARES

H1 2020 - FINANCIAL HIGHLIGHTS



Confirming guidance¹ of EPRA Earnings per share of €0.40 for 2020

BALANCE SHEET	JUN-20	DEC-19	Δ%	Δ
Investment Properties	€761.1m	€767.7m	(0.9)%	€(6.6)m
EPRA Net Tangible Assets	€440.1m	€443.7m	(0.8)%	€(3.6)m
EPRA Net Tangible Assets per share	€12.19	€12.29	(0.8)%	€0.10
Net LTV (consolidated)	39.0%	38.8%	n.m.	0.2 p.p.

INCOME STATEMENT	H1 2020	H1 2019	Δ%	Δ
Gross Rents	€22.2m	€17.8m	24.8%	€4.4m
NOI Margin	91.0%	89.5%	n.m.	150 bps
EBITDA	€15.5m	€11.2m	39.4%	€4.3m
Net Profit	€3.6m	€13.6m	(73.7)%	€(10.0)m
EPRA Earnings per share	€0.24	€0.20	20.8%	€0.04
Recurring FFO per share	€0.33	€0.22	50.0%	€0.11
EPRA Cost Ratio (incl. direct vacancy costs)	30.7%	37.8%	n.m.	(7.1) p.p.
EPRA Cost Ratio (excl. direct vacancy costs)	28.7%	36.8%	n.m.	(8.1) p.p.
All in cost of debt (blended)	2.01%	2.03%	n.m.	(2) bps
ICR	3.9x	3.2x	n.m.	0.7x



Note:
1)

Considering that the operational impact of the COVID-19 crisis on COIMA RES' business has been limited so far, COIMA RES is confirming its 2020 guidance of EPRA Earnings per share of €0.40. The guidance will be updated over the course of 2020 to reflect any meaningful update, also taking into account any potential future economic impact from the COVID-19 crisis

RENTS - GROWTH AND PAYMENTS



Like for like rental growth of +3.4% in H1 2020 (vs H1 2019), rent outstanding for H1 2020 at 1.9% of total rent due

GROSS RENTS (€m, IFRS consolidation perimeter)

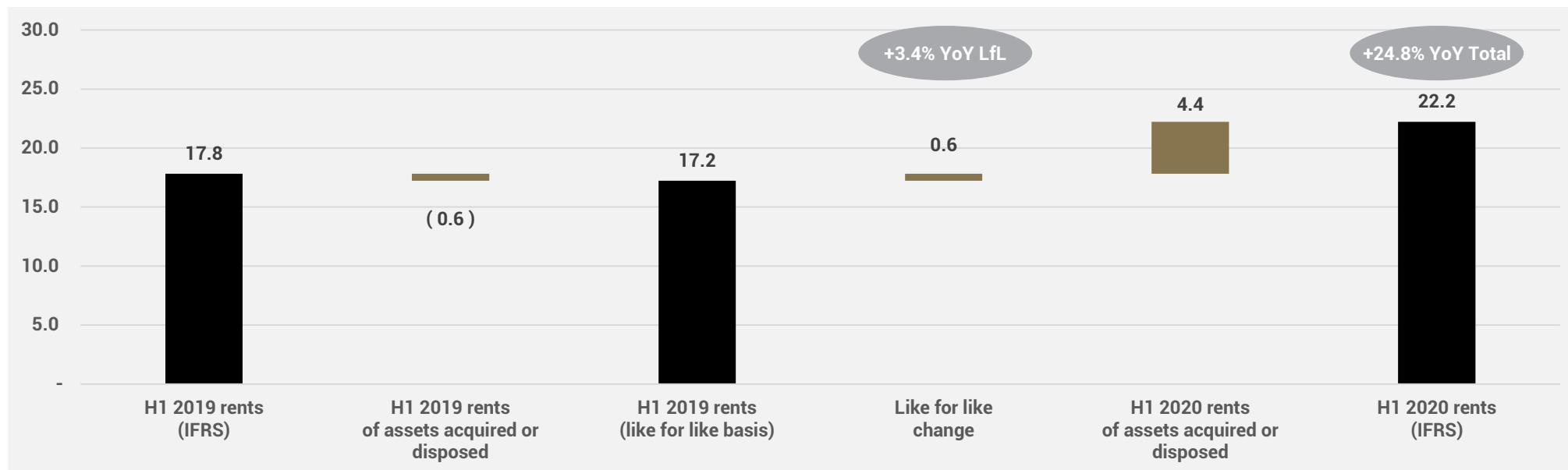

UPDATE ON H1 2020 RENTS DUE VS PAID (July 27th, 2020, IFRS consolidation perimeter)

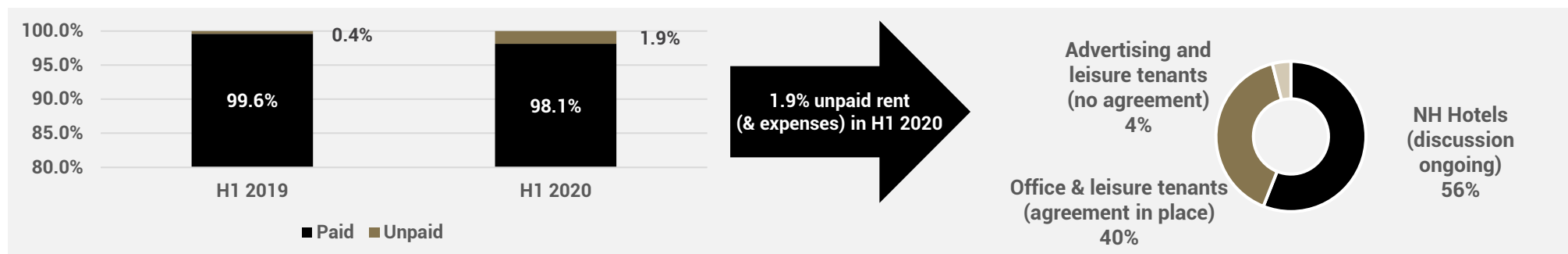

EPRA NAV - EVOLUTION



EPRA Net Tangible Assets per share decreased by 0.8% in H1 2020

■ EPRA NET TANGIBLE ASSETS PER SHARE EVOLUTION (€)

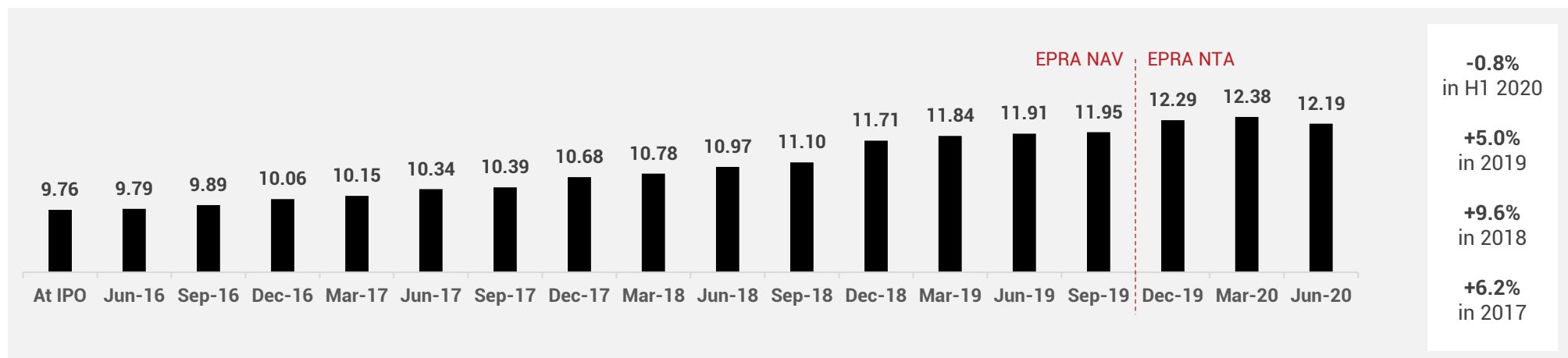

■ EPRA NET TANGIBLE ASSETS BRIDGE H1 2020 (€m)

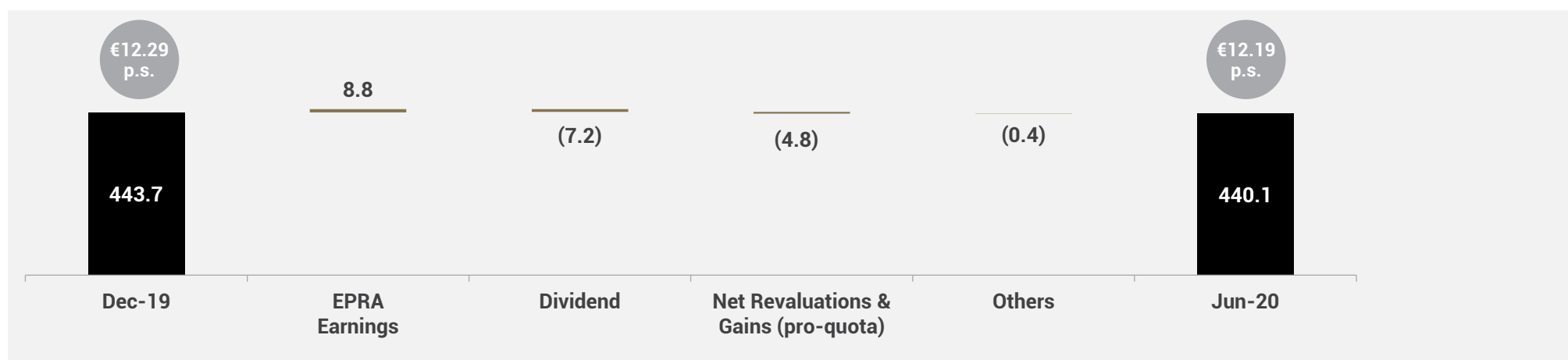

LTV AND DEBT STRUCTURE - EVOLUTION



Weighted average debt maturity of 2.9 years, "all in" cost of debt of ~ 2.0%, gross debt c. 87% hedged

NET LTV PROGRESSION (%)

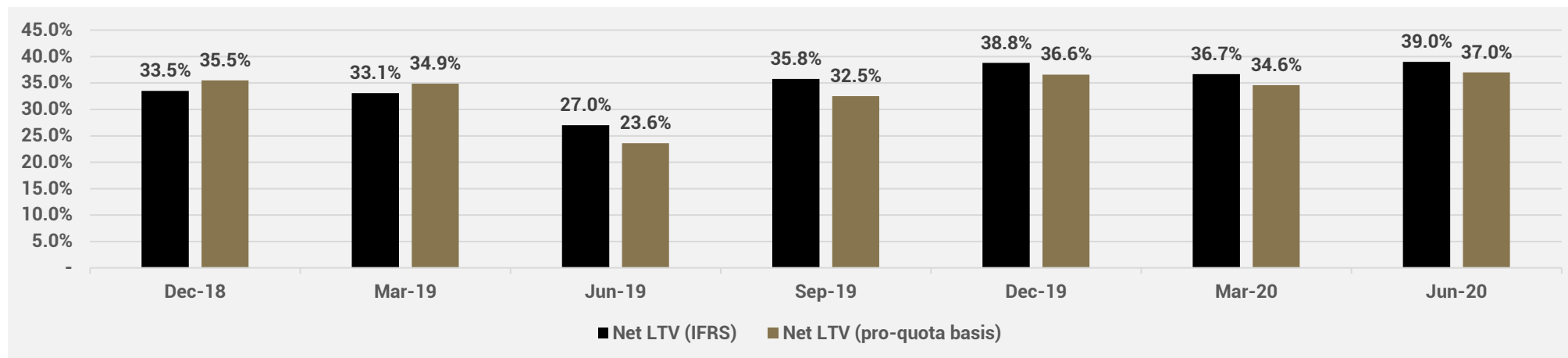

GROSS DEBT MATURITY PROFILE¹ (€m, Jun-20)

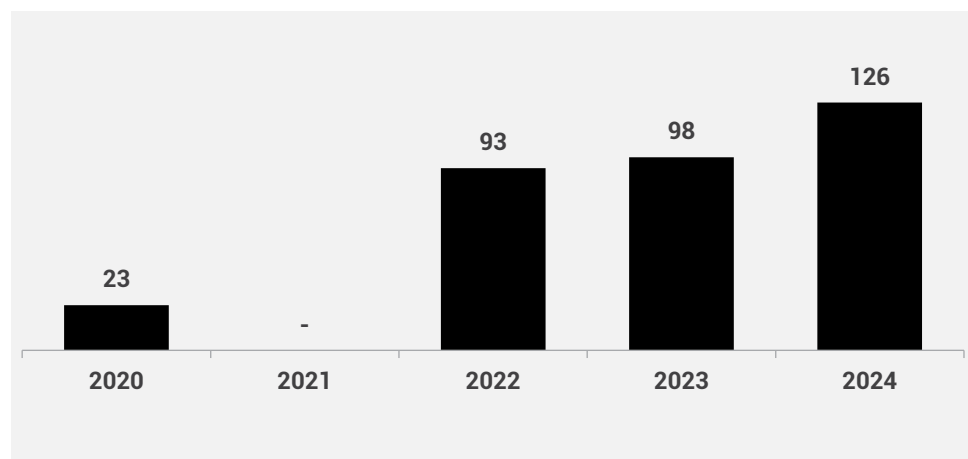

Note.
1) Excluding €6.5m of debt related to the bank branches (due in 2023) which will be reimbursed in 2020 on the back of the disposal already announced

COVENANTS OVERVIEW¹ (Jun-20)

Debt secured by assets	Maturity	Gross Debt	Gross LTV	Covenant LTV
M. Rosa, Tocqueville, Branches	2023	€71m	38%	< 60%
Pavilion	2023	€27m	37%	< 65%
Vodafone	2024	€126m	61%	< 65%
Gioiaotto	2022	€48m	58%	< 65%
Philips	2022	€25m	40%	< 55%
Microsoft	2020	€23m	23%	< 60%
Deruta	2022	€20m	44%	< 55%

LIQUIDITY PROFILE - EVOLUTION



Ample on balance sheet liquidity position, both on a consolidated and holding level basis

■ CASH ON BALANCE SHEET, CONSOLIDATED (€m)

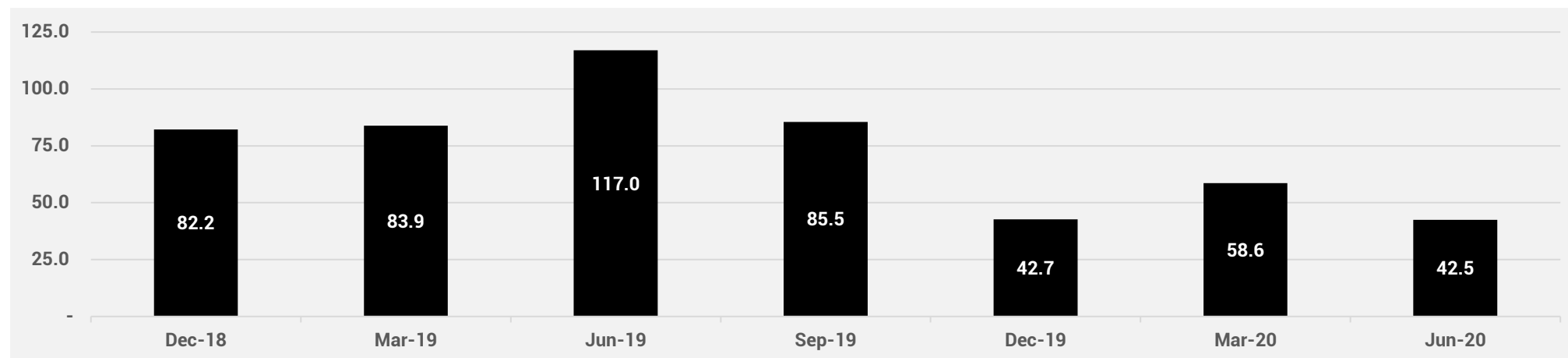

■ CASH ON BALANCE SHEET, HOLDING LEVEL (€m)

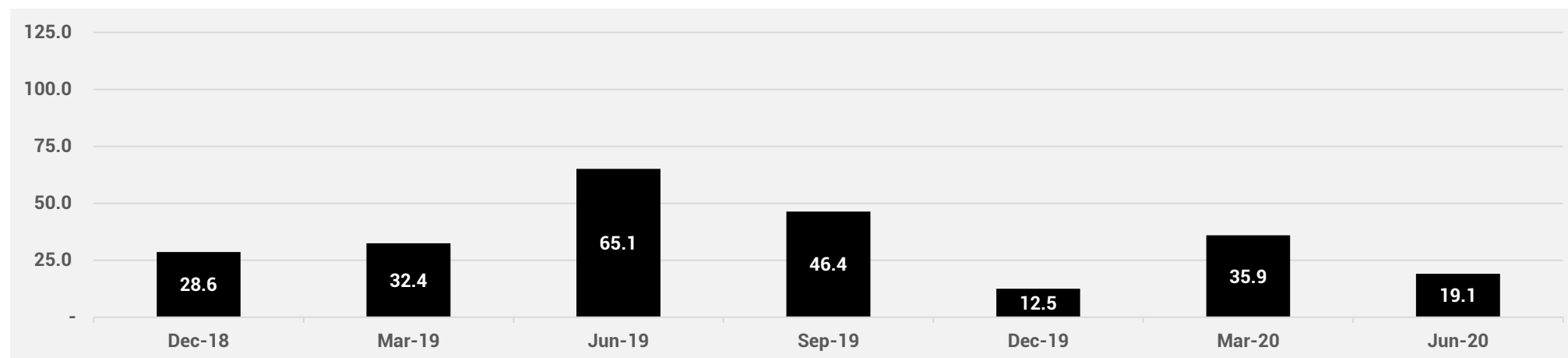

Key Highlights
Manfredi Catella, CEO

Financial Results
Fulvio Di Gilio, CFO

Portfolio & Asset Management
Matteo Ravà, Head of Asset Management

Market Outlook
Gabriele Bonfiglioli, Head of Investments

Closing Remarks
Manfredi Catella, CEO

Appendix

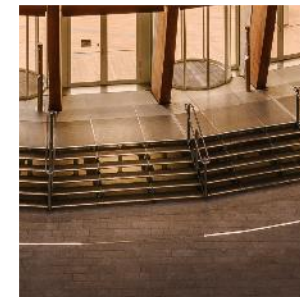
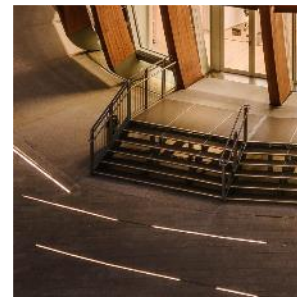
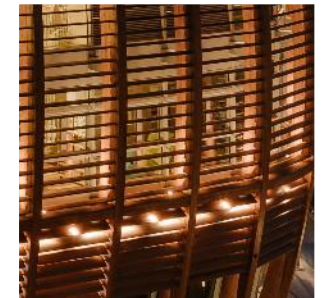
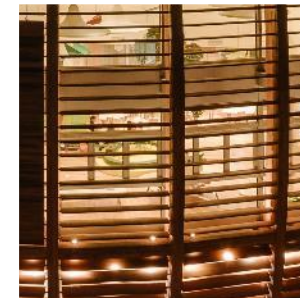
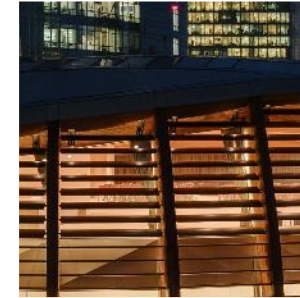

COIMARES

PORTFOLIO - BREAKDOWN



A high quality portfolio focused on Milan offices with a high sustainability profile

€690 MILLION
PORTFOLIO
 (ON A PRO-QUOTA BASIS)

85% OFFICES

90% MILAN

50% PORTA NUOVA

65% LEED CERTIFIED

4.9 YEARS WALT

5.1% EPRA NET INITIAL YIELD

5.3% EPRA TOPPED-UP NET INITIAL YIELD

2.1% EPRA VACANCY RATE

OFFICE PORTFOLIO ON AVERAGE LESS THAN 500 METERS FROM METRO / TRAIN STATIONS

BREAKDOWN BY END USE

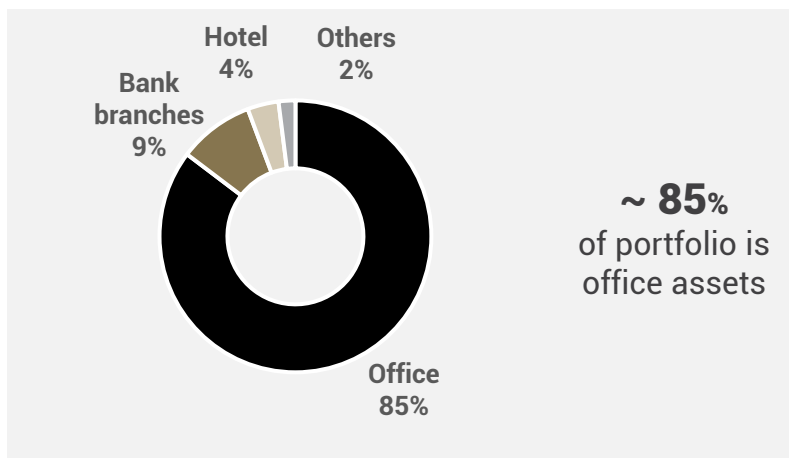

BREAKDOWN BY LOCATION

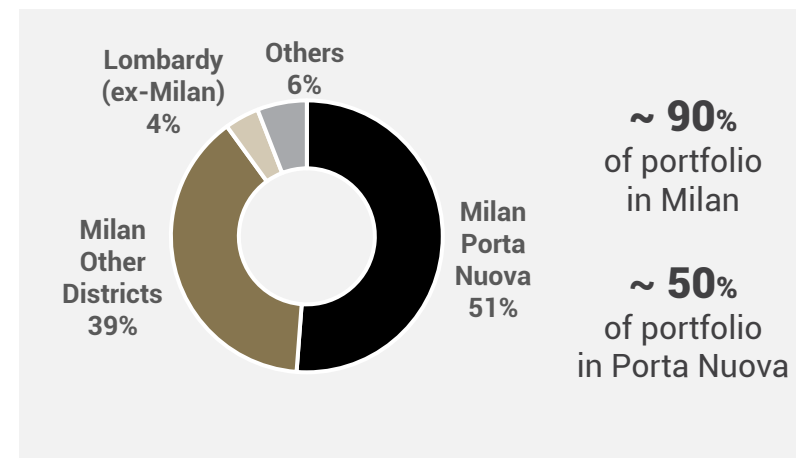

BREAKDOWN BY PROFILE

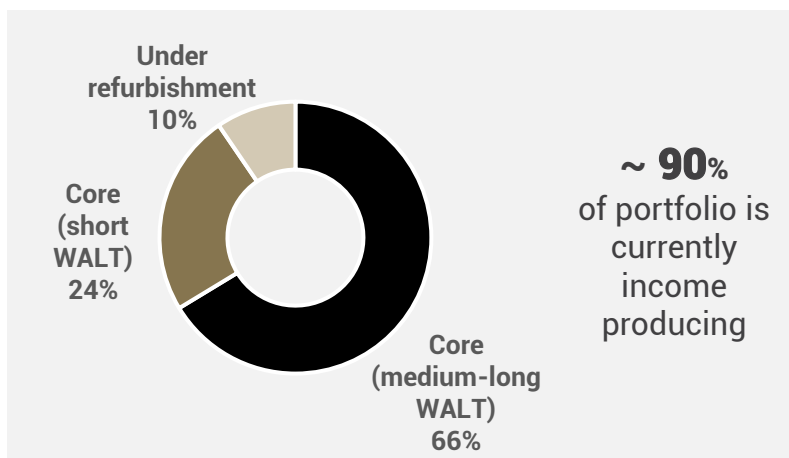

BREAKDOWN BY CERTIFICATION

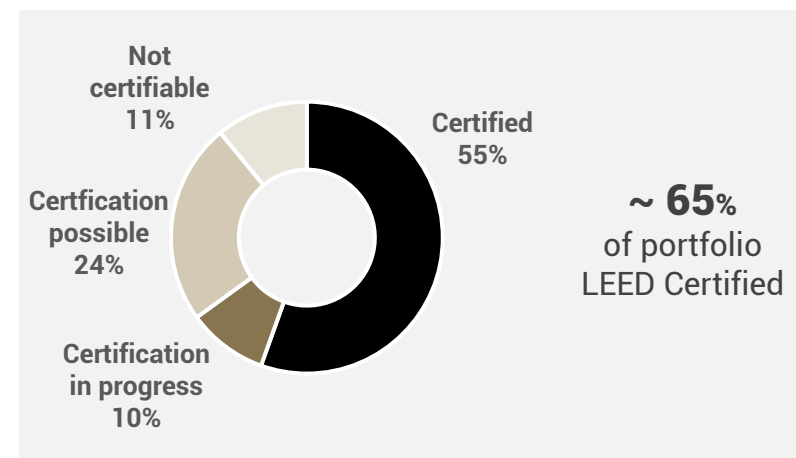

Note:

- 1) Breakdown of Gross Asset Value on a pro-quota basis
- 2) Not certifiable assets refer to bank branches portfolio and telecom assets

TENANT BASE - OVERVIEW



A predominantly office tenant portfolio with a limited component of hotel and retail tenants

RENTS BY PROPERTY END USE

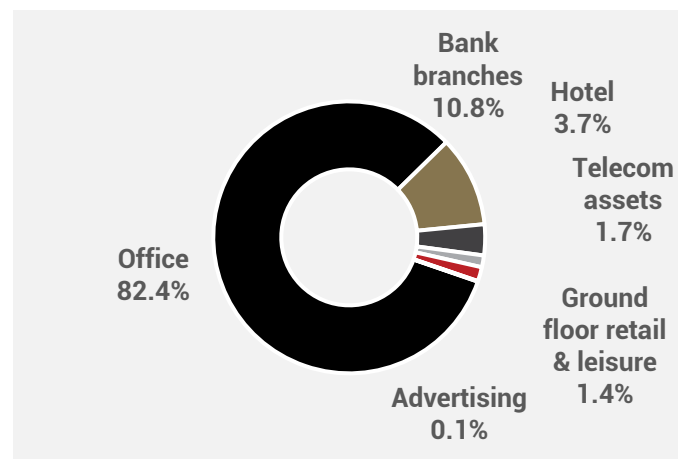

RENTS BY TENANTS

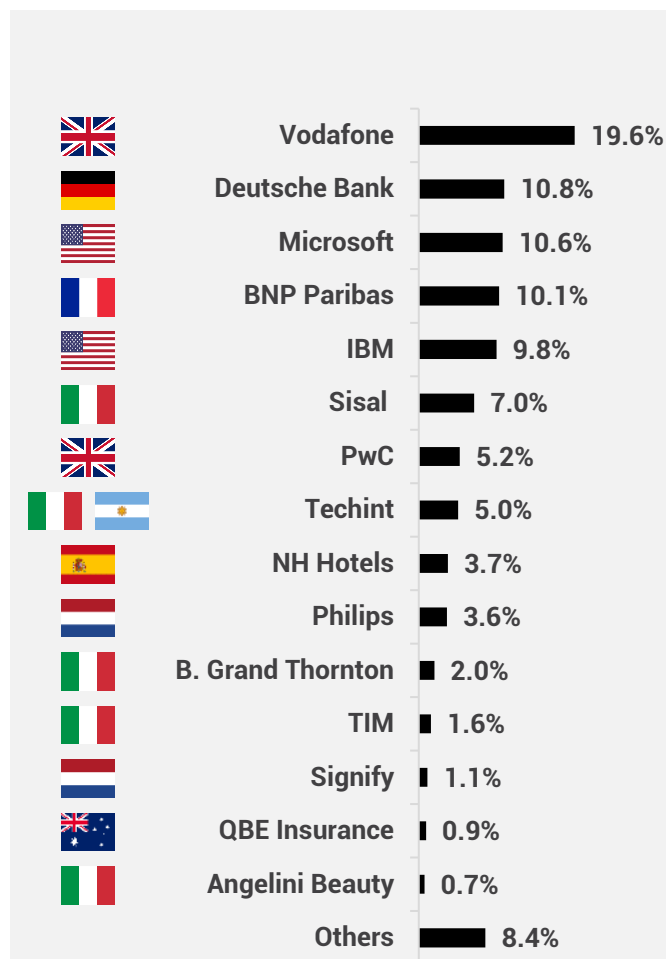

Sector	Revenues (2019)	Credit Rating (27-Jul-20)
Telecom	£44bn	BBB
Bank	€23bn	BBB+
Tech	\$126bn	AAA
Bank	€46bn	A+
Tech	US\$77bn	A
Gaming	€0.8bn (2018)	B1
P. Services	US\$42bn	n.a.
Industrial	\$23bn (2018)	n.a.
Hotel	€2bn	B-
Healthcare	€18bn	BBB+
P. Services	n.a.	n.a.
Telecom	€18bn	BB+
Industrial	€6bn	BBB-
Insurance	\$15bn	A-
Consumer	€2bn (2018)	n.a.

RENTS BY UNDERLYING SECTOR

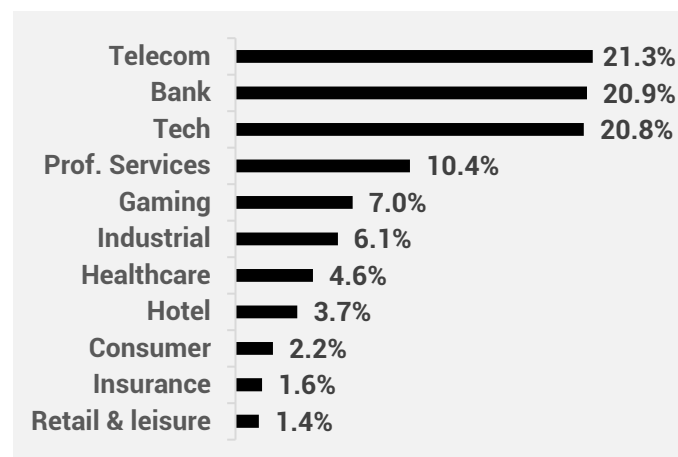

Note: Data above are based on current passing rent (on a pro-quota basis)

PORTFOLIO - CAPITAL VALUE IN H1 2020



Capital value down 0.7% in H1 2020, mainly related to downward revision of inflation curve

PORTFOLIO EVOLUTION IN H1 2020 (€m, pro-quota basis)

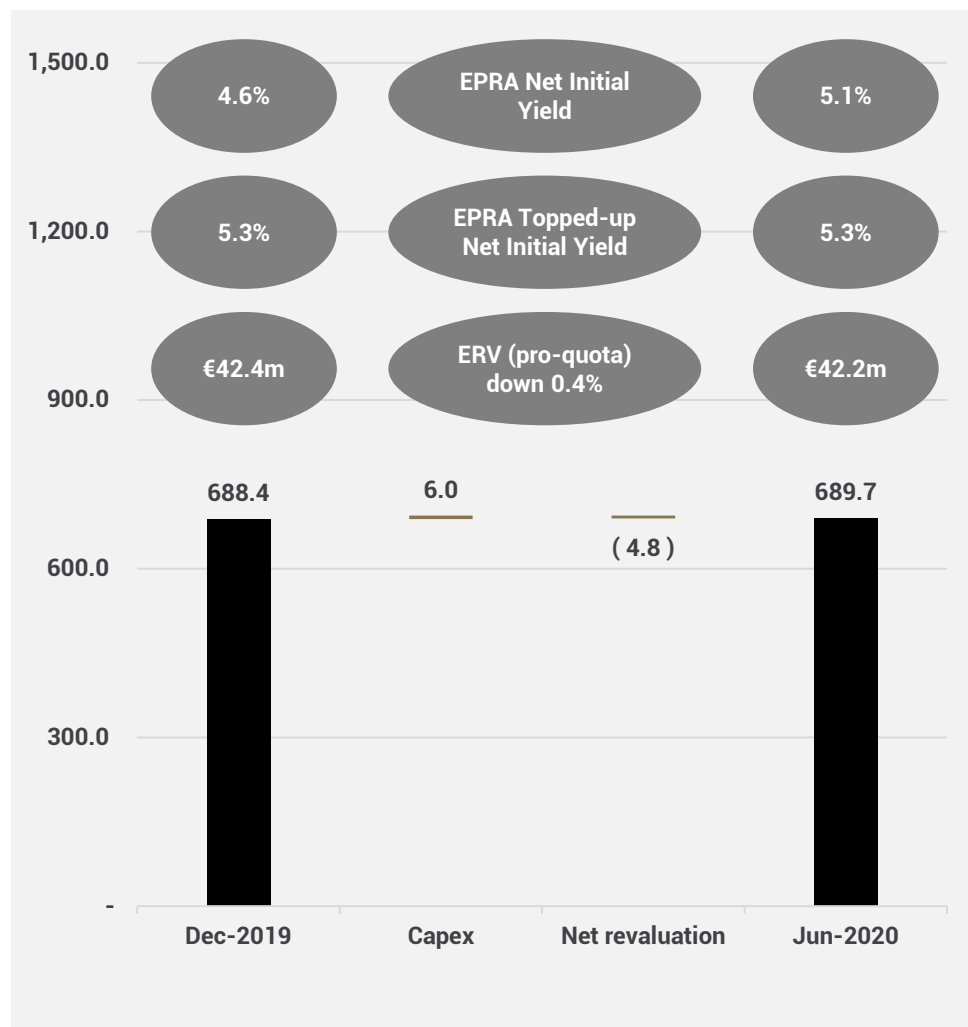

CAPITAL VALUE GROWTH IN H1 2020 (% , pro-quota basis)

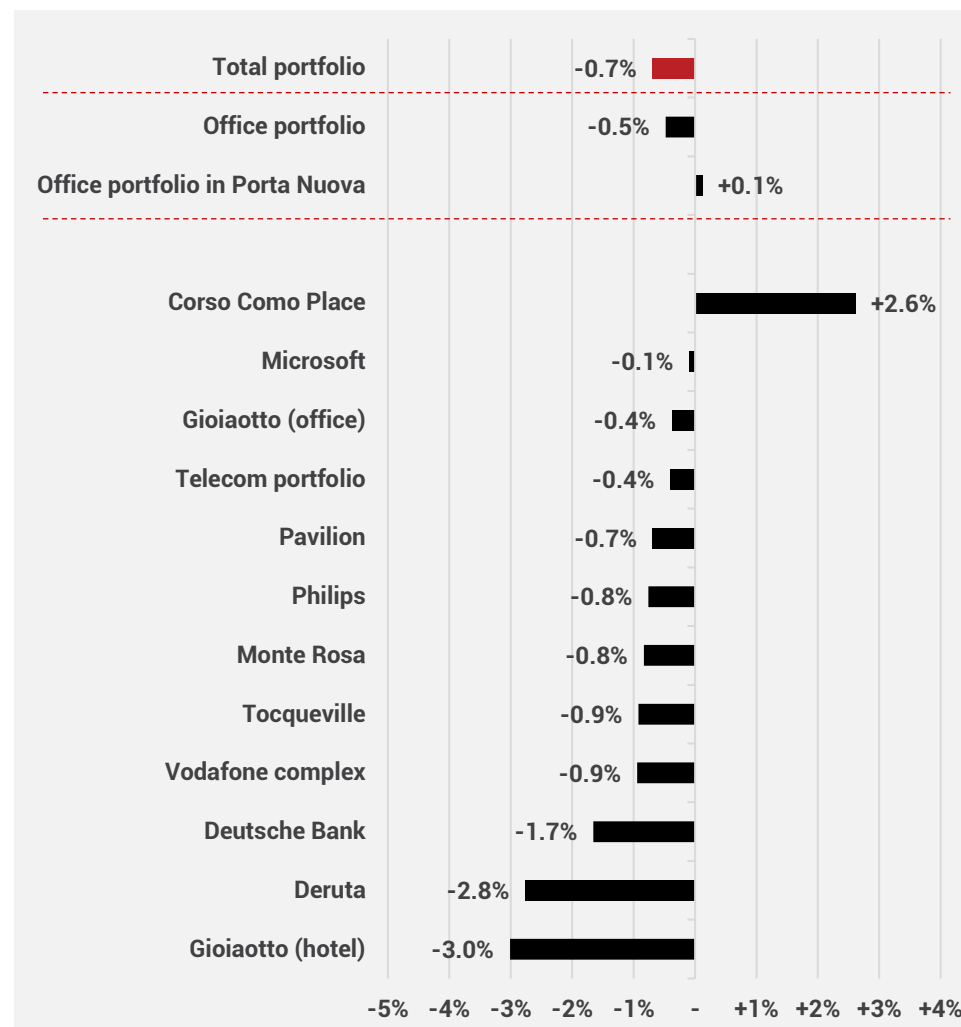

OFFICE PORTFOLIO - VALUATION OVERVIEW



A high quality portfolio conservatively valued vs current Milan office prime / secondary yields

OVERVIEW

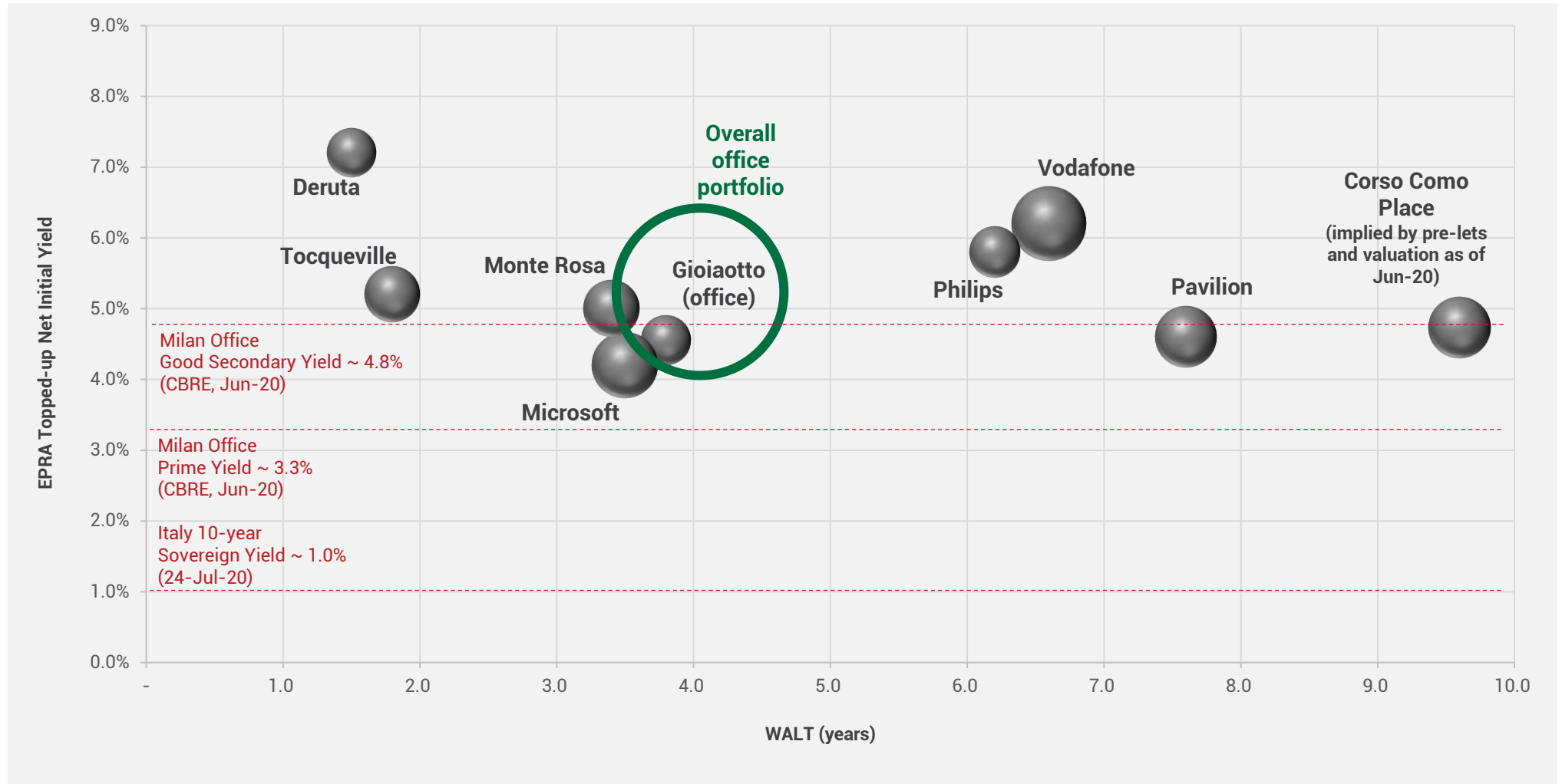

Note: Size of bubbles indicates the Gross Asset Value (pro-quota)

TENANTS - GRADUALLY BACK IN THE OFFICE



Tenants are expected to gradually re-occupy their office space from September onwards

OFFICE ASSETS ESTIMATED UTILISATION IN 2020

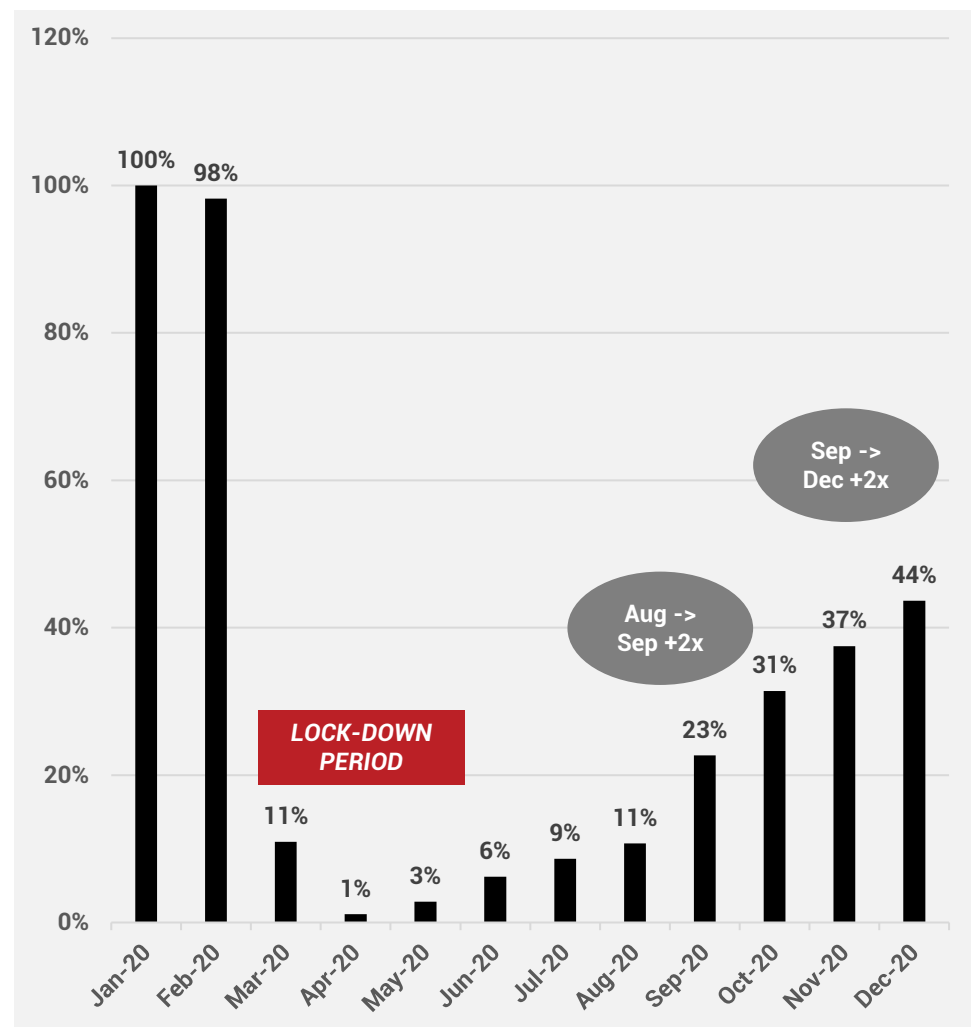

DETAILS OF DATA ANALYSIS

- COIMA RES estimate based on feedback from top 10 office tenants
 - Vodafone
 - Microsoft
 - BNP Paribas
 - IBM
 - Sisal
 - PwC
 - Techint
 - Philips
 - Bernoni Grand Thornton
 - Signify

- Asset utilisation estimate
 - No. of workstations occupied divided by total workstations
 - Aggregate result weighted by pro-quota rent associated to tenant

TOCQUEVILLE - UPDATE



Currently studying two main refurbishment scenarios for Tocqueville, with different capex intensity

■ SCENARIO 1

- Refurbishment of existing building
 - Creation of an additional smaller building
- Current commercial surface of 9,604 sqm
 - Potential increase in sqm of +5%
- Targeting to achieve both LEED & WELL certifications

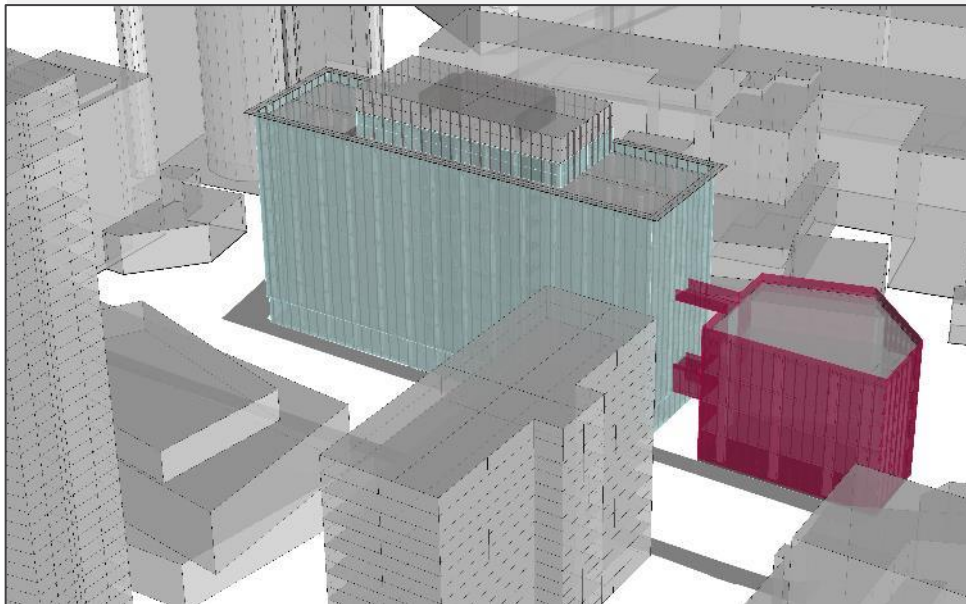

■ SCENARIO 2

- Refurbishment of existing building
 - Increase in sqm by creating additional floor(s)
- Current commercial surface of 9,604 sqm
 - Potential increase in sqm of +5%
- Targeting to achieve both LEED & WELL certifications

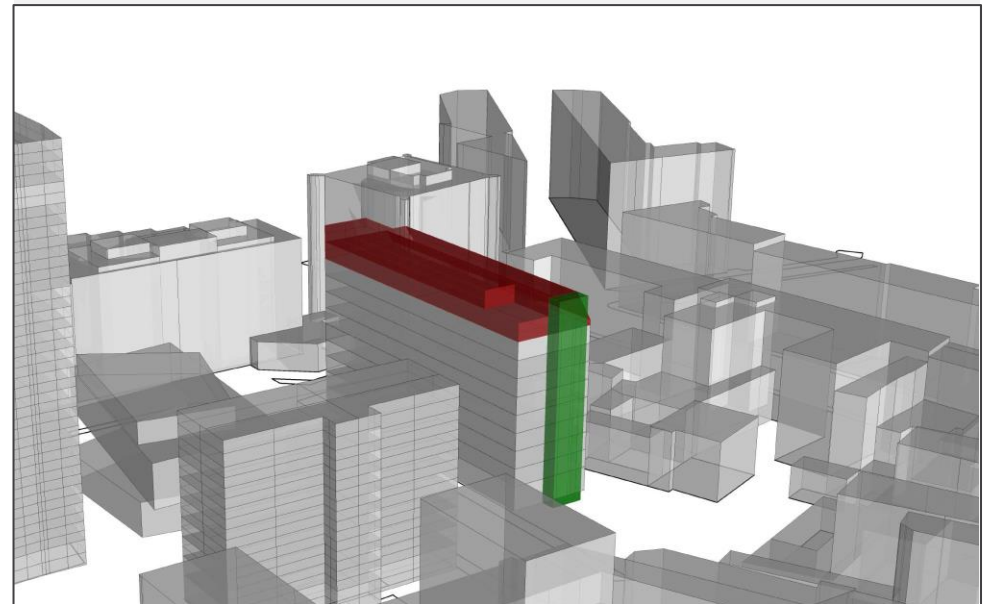

CORSO COMO PLACE - UPDATE



Corso Como Place project on track for completion in 2020

PROJECT UPDATE

- Building site advancement rate at 85% at 30-Jun-20
 - Up 6 p.p. from 79% at 31-Mar-20
- Construction timeline
 - Building site halted: 13-Mar / 03-May
 - Building site adaptation period: 04-May / 18-May
 - Construction works post COVID-19: from 21-May
 - Delay of c. 150 days (+20% of construction time)
- De-densifying the construction site
 - Added one extra shift (from 1 to 2 shifts)
 - Reduced no. of workers per shift from 250 to 140
- Building site adaptation costs
 - Extra costs estimated at c. €1m
 - Representing c. 0.6% of total project cost of €169m
- Pre-let 95% of development surfaces in 2019
 - Delivery to Accenture / Bending Spoons by the end of 2020



CORSO COMO PLACE - VALUATION UPSIDE



A market valuation of the asset, upon completion, could yield additional NAV of €0.40-0.90 per share to COIMA RES

VALUATION SIMULATION (€m, entire complex)

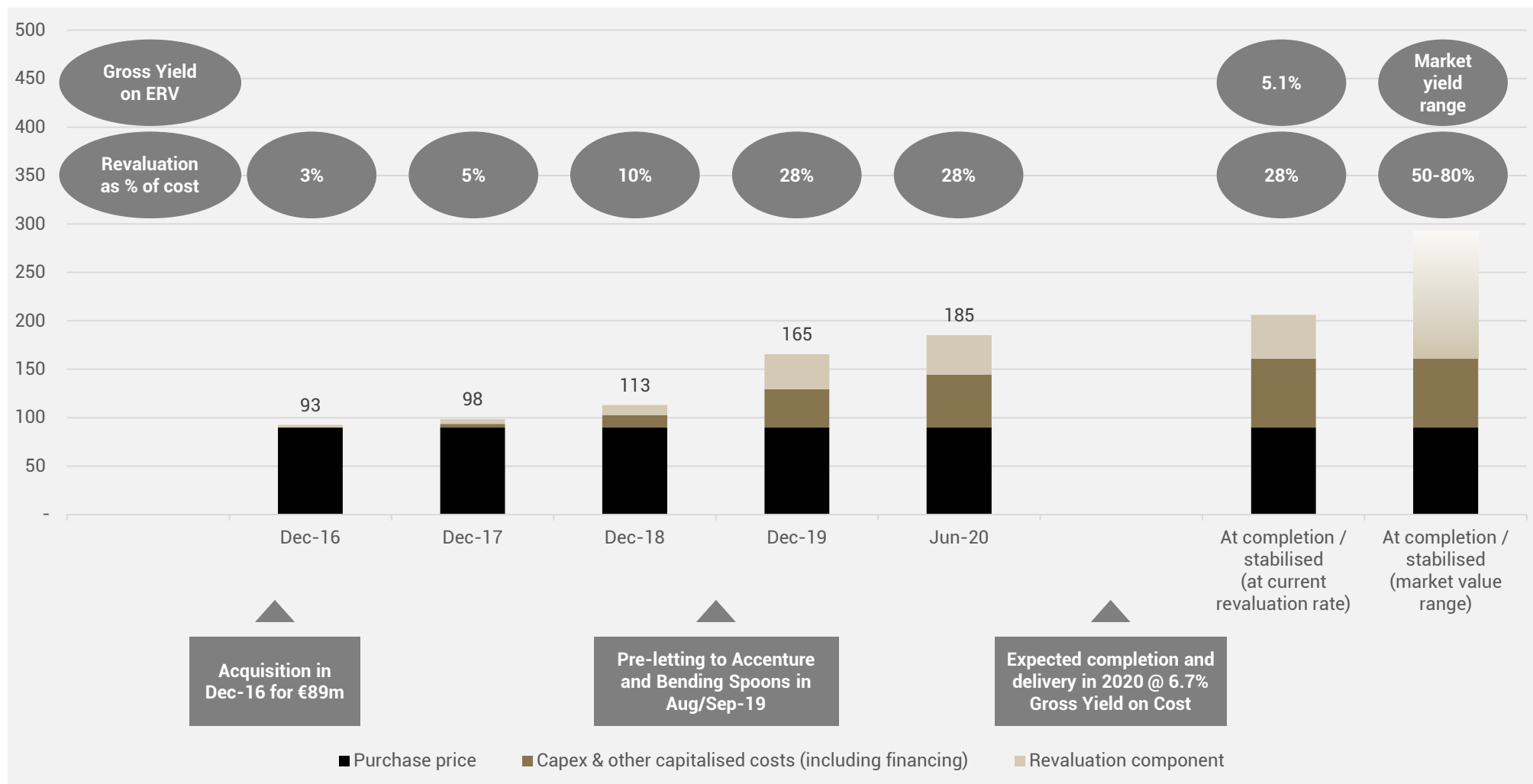

Key Highlights
Manfredi Catella, CEO

Financial Results
Fulvio Di Gilio, CFO

Portfolio & Asset Management
Matteo Ravà, Head of Asset Management

Market Outlook
Gabriele Bonfiglioli, Head of Investments

Closing Remarks
Manfredi Catella, CEO

Appendix

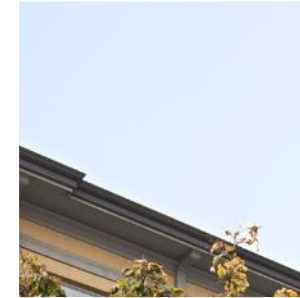

COIMARES

ITALY - INVESTMENT MARKET IN H1 2020



Investment volumes in H1 2020 only marginally affected by the COVID-19 emergency

INVESTMENT VOLUMES INTO ITALY BY ASSET CLASS (€bn)

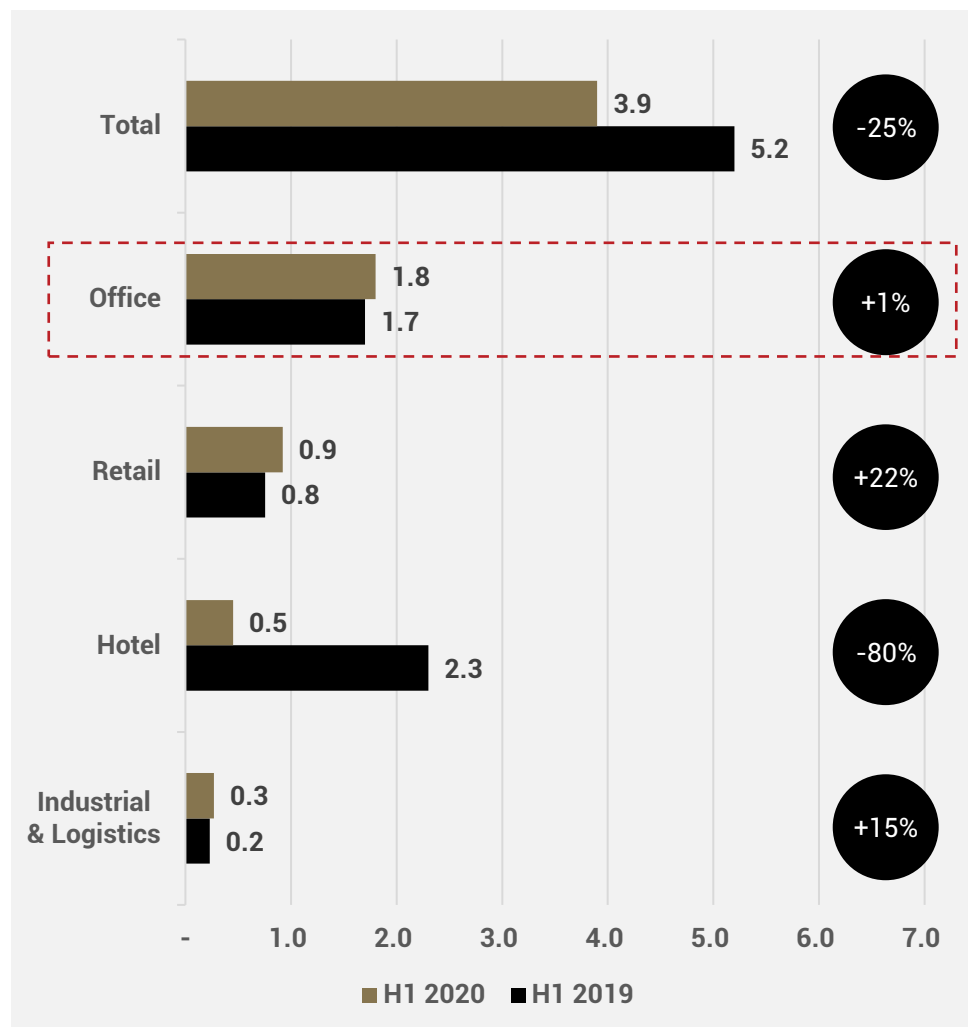

INVESTMENT VOLUMES INTO ITALY BY LOCATION (%)

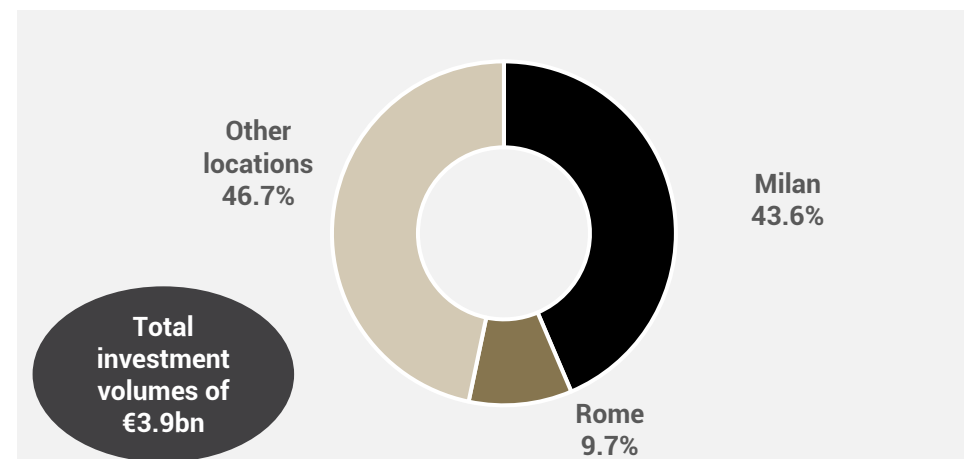

INVESTOR ORIGIN (%)

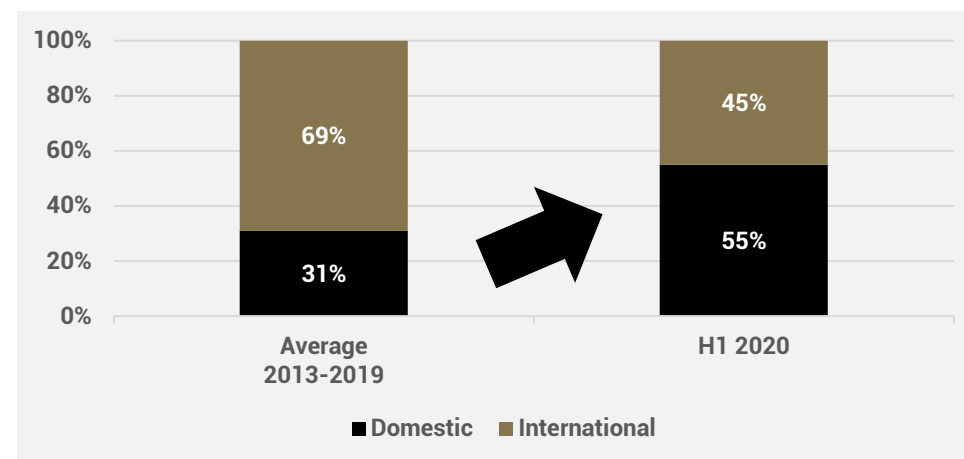

MILAN OFFICES - INVESTMENT ENVIRONMENT



Investment volumes in H1 2020 only marginally affected by the COVID-19 emergency, stable yield environment

INVESTMENT VOLUMES (€bn)

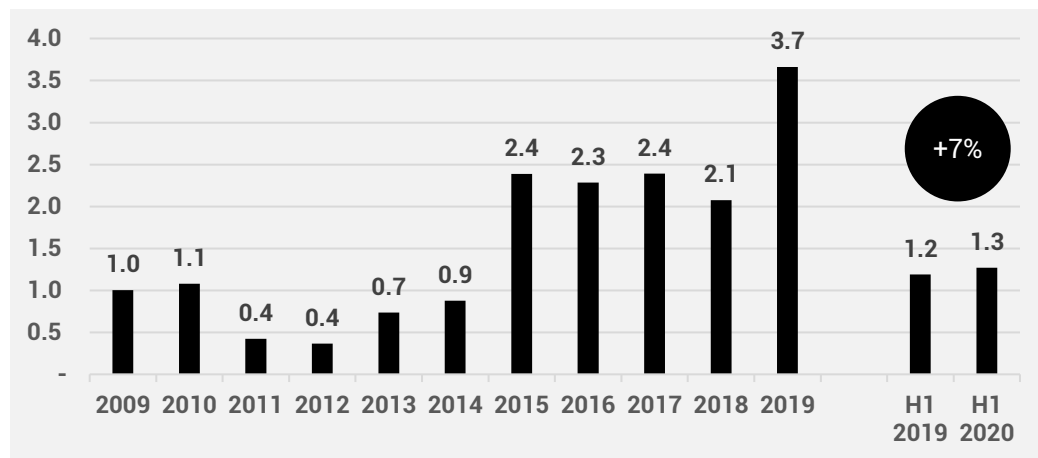



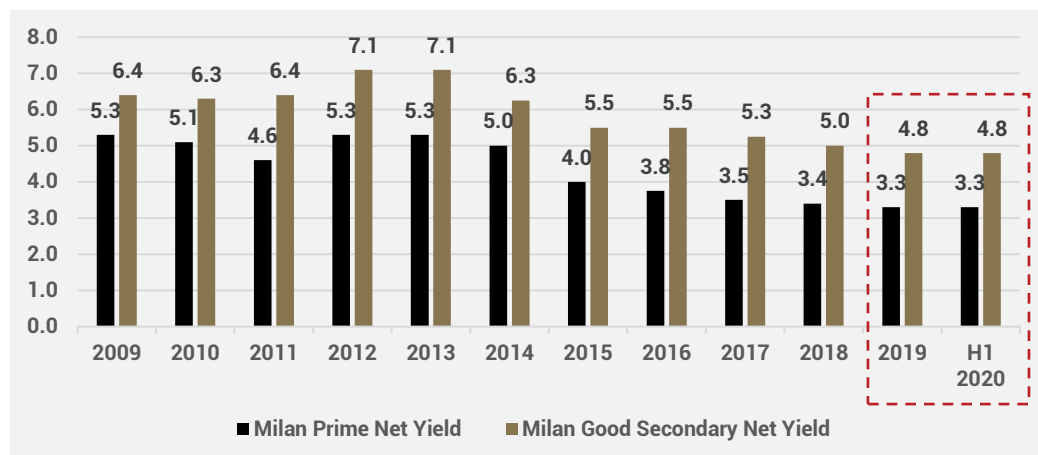





YIELD EVOLUTION (%)



Source: CBRE, COIMA

KEY TRANSACTIONS

Core	
	Via Orefici / Cantù Core asset in CBD Closed (c. 3.3% NY)
	Via Mazzini Core asset in CBD Closed (c. 3.5% NY)
	Via Armorari Sale & Lease-back Closed (c. 3.1% NY)
	Via Dante Core asset in CBD Closed (c. 3.5% NY)
	Via Moscova Core asset in Centre Ongoing disposal
	Via Cernaia Core asset in Centre Ongoing disposal
Value-add	
	UBI Portfolio Value-add Closed
	MPS Portfolio Value-add Being finalised
Development	
Slowing down	

MILAN OFFICES - LEASING ENVIRONMENT



Slower take-up level in H1 2020 (-32%), record low vacancy for Grade A space at 1.7%, stable prime rent at €600/sqm

TAKE UP BY GRADE ('000 sqm)

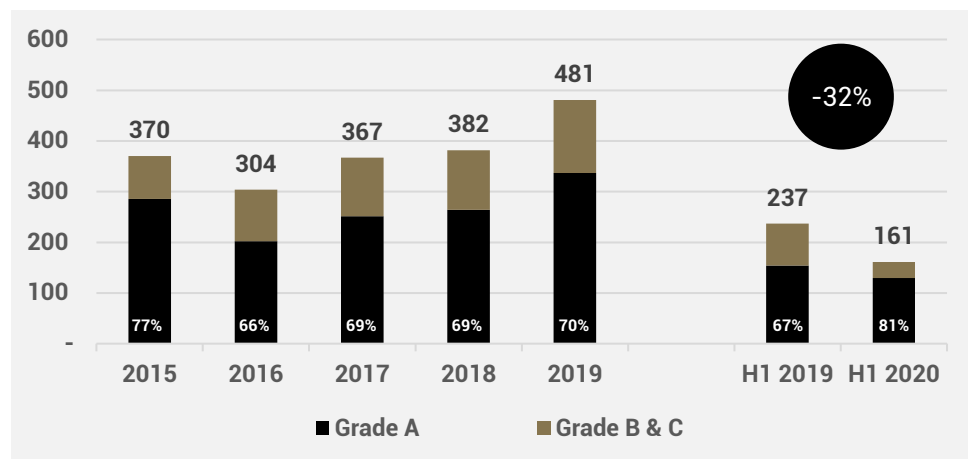

VACANCY RATE BY GRADE (%)

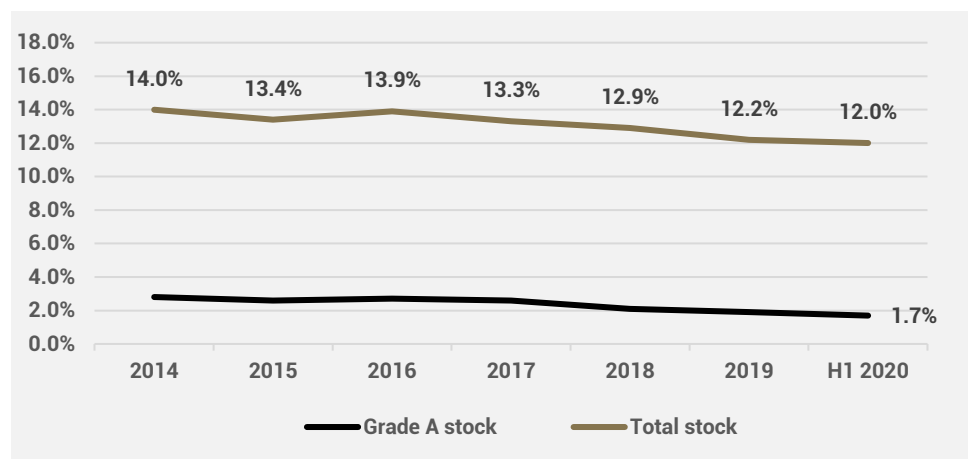

RECENT LEASING TRANSACTIONS

Historical Centre	Tenant	Rental level
Via Armorari	Credit Agricole	€700/sqm
Via Turati	Off-White	€600/sqm
Semi-Centre	Tenant	Rental level
Via Filzi	Pirola Pennuto Zei	€400/sqm
Porta Nuova	Tenant	Rental level
Via Melchiorre Gioia	Financial institution	€500/sqm
Viale Sturzo	Oracle	€500/sqm
Via Restelli	Groupama	> €500/sqm
Periphery	Tenant	Rental level
Via Piranesi	IED	€250/sqm
Santa Giulia	Saipem	€280/sqm

Source: CBRE, JLL, COIMA

MILAN OFFICES - DEMAND & SUPPLY DYNAMICS



Speculative pipeline currently 50-60% pre-let and likely to be outstripped by demand, even in a stress scenario

■ SPECULATIVE PIPELINE BY YEAR (sqm)

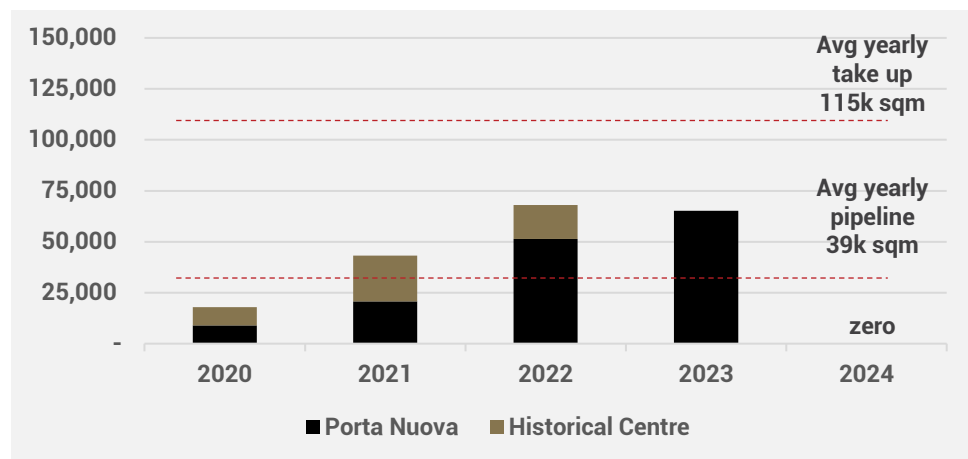

■ PIPELINE: HISTORICAL CENTRE 60% PRE-LET

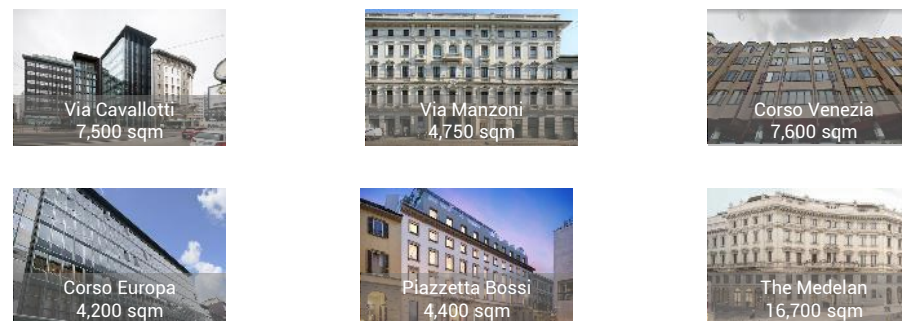

■ PIPELINE: PORTA NUOVA 50% PRE-LET

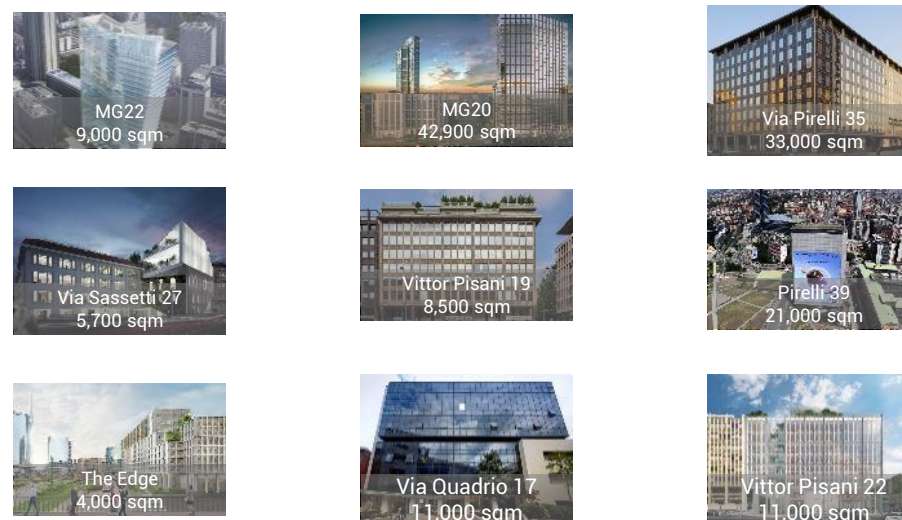

■ DEMAND & SUPPLY IN CENTRAL BUSINESS DISTRICTS (sqm)

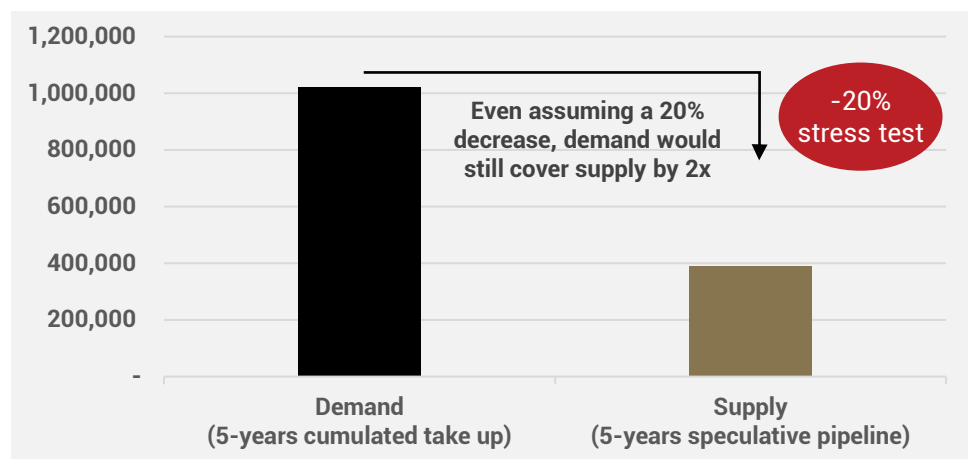

Source: COIMA elaboration on market data

Key Highlights
Manfredi Catella, CEO

Financial Results
Fulvio Di Gilio, CFO

Portfolio & Asset Management
Matteo Ravà, Head of Asset Management

Market Outlook
Gabriele Bonfiglioli, Head of Investments

Closing Remarks
Manfredi Catella, CEO

Appendix

COIMARES

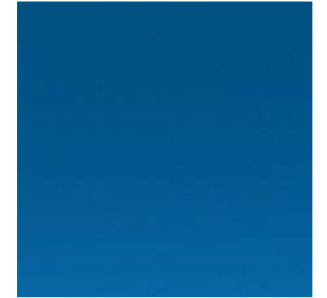

WORKING FROM HOME - CONSIDERATIONS



Working from home likely to grow going forward, but offices likely to retain a central role

MORGAN STANLEY CEO (Apr-20)

"We've proven we can operate with effectively no footprint...that tells you an enormous amount about where people need to be physically...can I see a future where part of every week, certainly part of every month, a lot of our employees will be at home? Absolutely."

MORGAN STANLEY CEO (Jul-20)

"Something I said, I think on the last call or on a TV interview was picked up and blown out of proportion...I said we'd learned to live with all of our people working from home or most of them. And therefore, that gave us an opportunity to rethink our real estate strategy. That was interpreted by some in the media as we're going to radically shift our footprint in our major locations. That's not going to happen. We're committed to the major cities in this world where we have our headquarters...Morgan Stanley will remain a major player in the commercial real estate market globally. However, when we think about our DCP backup centres, when we think about our consolidation in various offshore centres and our density management, when we think about some of our excess capacity across our branch network, is this the time to start addressing those issues. Are we going to be radically expanding real estate across the firm over the next 5 years? I doubt that very much. But are we going to be radically shrinking it? I doubt that very much."

WORKING FROM HOME IN EUROPE: HISTORICAL TRENDS (% of employees in EU28, Eurostat data)

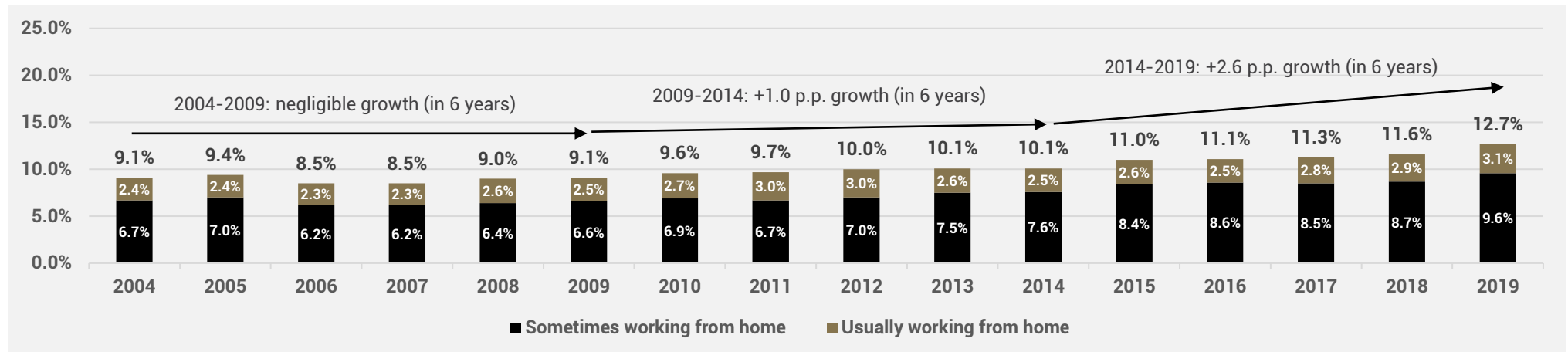

Source: Morgan Stanley

POST-COVID SCENARIOS - CONSIDERATIONS



Lower employee attendance in the office due to increased remote working to be partially offset by lower density

POTENTIAL POST-COVID EVOLUTION (Goldman Sachs Research)

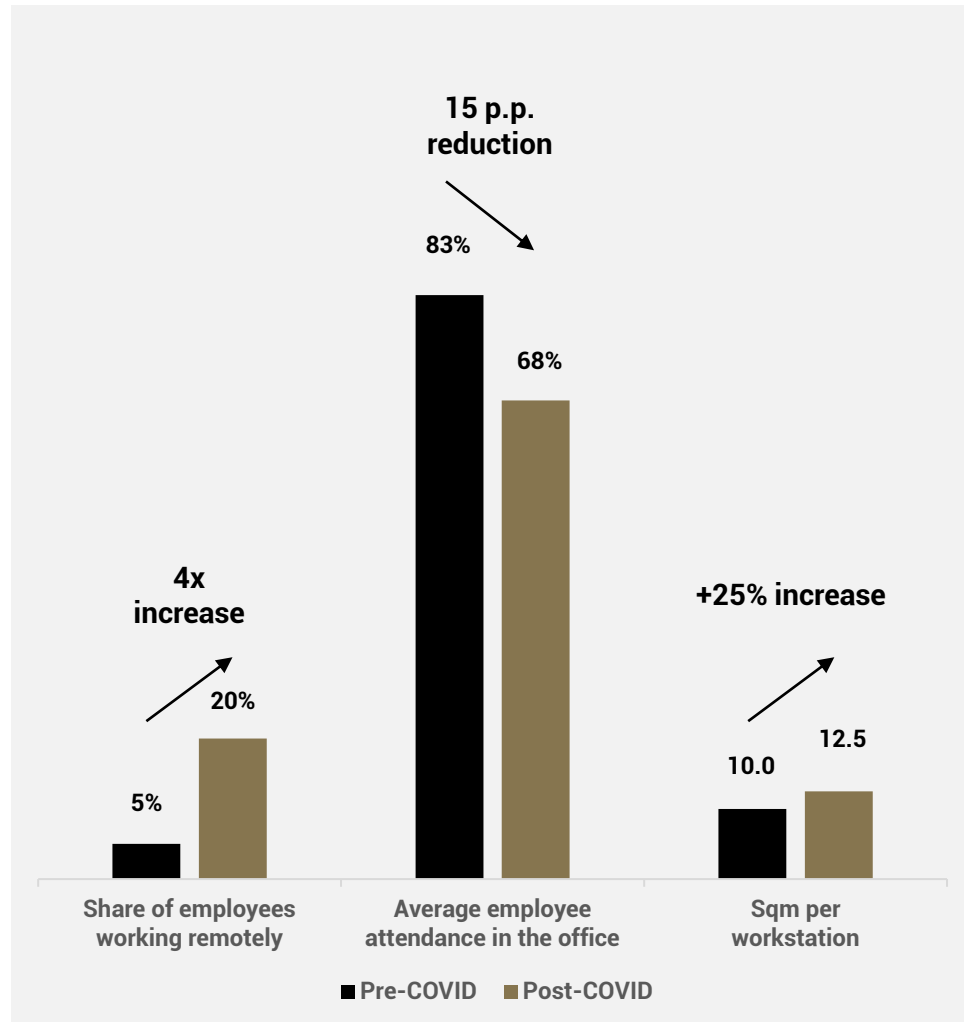

EXAMPLE OF OFFICE SPACE DE-DENSIFICATION (COIMA)

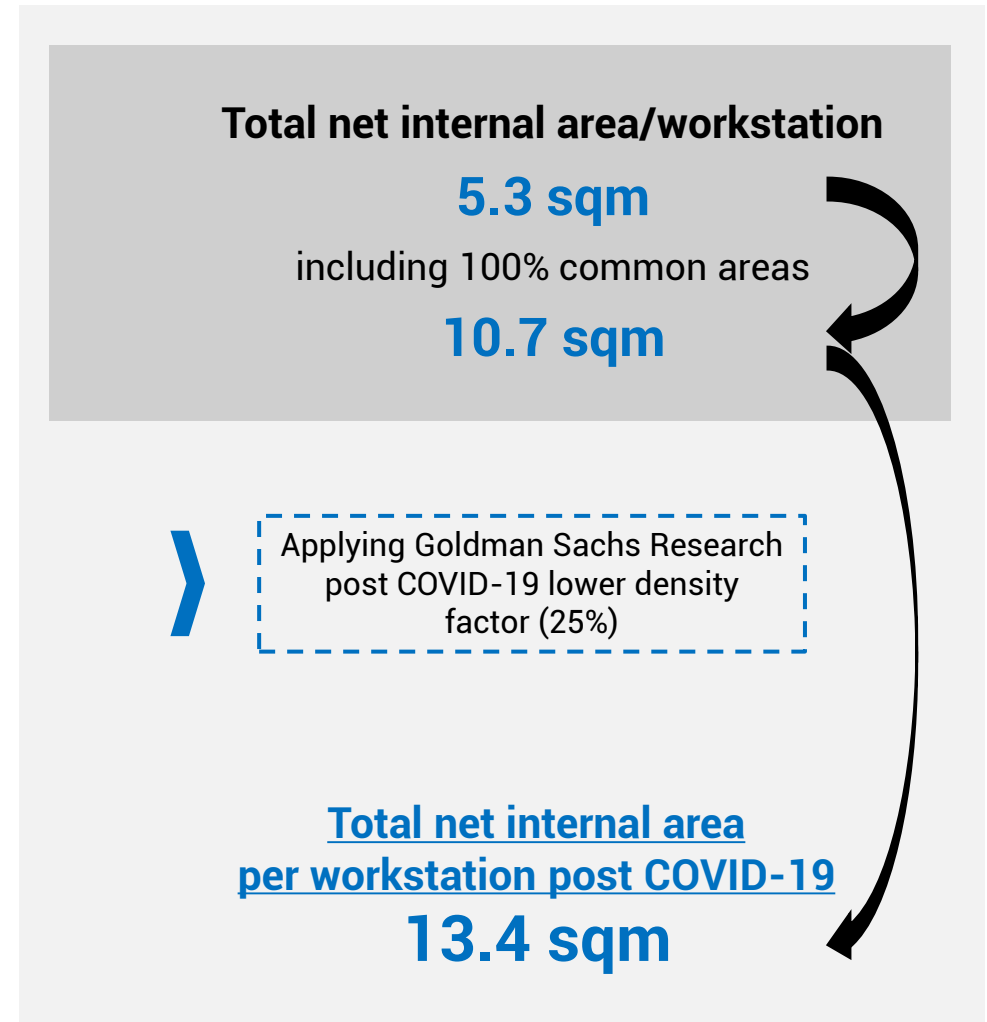

PORTA NUOVA RE-START - LIDO BAM



Proactively managing public spaces and footfall in a post COVID-19 world

PORTA NUOVA

- 575,000 sqm of public spaces
- 20,000 residents
- 35,000 employees
- > 10 million visitors per year
- 160,000 sqm of public park



RE-THINKING OF PUBLIC SPACES MANAGEMENT

- Priorities
 - Health & Safety first
 - Enable social distancing
 - Maintain area alive
 - Stimulate footfall



LIDO BAM: ENJOYING SOCIAL DISTANCING

- Relax area with umbrellas and sunbeds inside BAM park



- Leveraging on digitalisation
 - Porta Nuova App created in 2 weeks
 - 2,600+ users in 12 days on Lido BAM booking service



PORTA NUOVA RE-START - MILANO CITY STUDIOS



Addressing COVID-19 effects on events management business by kicking off digital production business

EVENTS MANAGEMENT BUSINESS

- The Mall in Porta Nuova event business
 - 23 events in 2019
 - 133,000 guests & visitors in 2019

Multifunctional space in Porta Nuova used for fashion shows, conventions, presentations, gala dinners, etc.

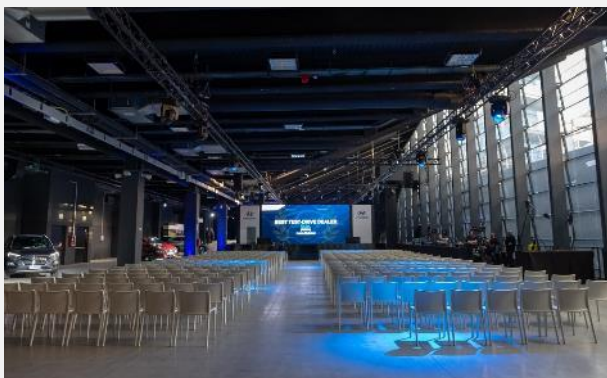

...COVID-19 / Lockdown...

DEMAND FOR PHYSICAL EVENTS



DEMAND FOR DIGITAL PRODUCTION



ACTIVATION OF DIGITAL PRODUCTION BUSINESS

- Social distancing leading to a decrease in the number of physical events
 - Strong demand for digital production services by corporates
- Milano City Studios are borne
 - Real production studios
 - Realization of events, digital productions, spots advertising and television footage
 - Project kick started in only 4 months, during the lock-down
 - Unprecedented model in Italy for the production of content and events
 - More than 550 total production days expected for the first 18 months of activity
- Key sites
 - The Studio (1,200 sqm)
 - The Theatre (3,000 sqm)
 - The House (1,000 sqm)
 - The Square (5,500 sqm)
 - The Park (9,500 sqm)



Variety of shooting areas, new technologies, on demand services and centralised logistics, iconic & sizeable spaces, etc.

CLOSING REMARKS



ASSET MANAGEMENT	<ul style="list-style-type: none">■ Completion of Corso Como Place project<ul style="list-style-type: none">– Project advancement rate of approx. 85% as of June 2020– Delivery of the buildings A and C to Accenture and Bending Spoons– Letting of residual portion of building C■ Evaluating refurbishment scenarios on other short WALT assets
PORTFOLIO OPTIMISATION	<ul style="list-style-type: none">■ Further reducing bank branches exposure<ul style="list-style-type: none">– Residual exposure of €68m (58 branches)– Branches are 52% in Lombardy (of which 10% in Milan) and 39% in main Italian cities (capoluoghi regionali)■ Opportunistic disposal of other non-strategic, non-core and mature assets
CORPORATE OPTIMISATION	<ul style="list-style-type: none">■ Optimisation of corporate structure<ul style="list-style-type: none">– Reduction in complexity and costs by streamlining fund structures– Access to better financing terms by pooling high quality assets
INVESTMENTS	<ul style="list-style-type: none">■ Completion of Gioia 22 acquisition, subject to certain transaction conditions<ul style="list-style-type: none">– Planned for the end of 2021– Exact stake within the 10-25% range to be determined on the basis of market conditions and COIMA RES firepower– Porta Nuova exposure to grow from 51% to 54-58% (pro-forma)



Key Highlights
Manfredi Catella, CEO

Financial Results
Fulvio Di Gilio, CFO

Portfolio & Asset Management
Matteo Ravà, Head of Asset Management

Market Outlook
Gabriele Bonfiglioli, Head of Investments

Closing Remarks
Manfredi Catella, CEO

Appendix: Financials & Portfolio
Appendix: Governance & Sustainability

COIMARES



COIMA RES - A RESILIENT INVESTMENT PROFILE



- 1 HIGH QUALITY PORTFOLIO WITH CORE PROFILE**
85% OFFICES, 90% IN MILAN, 50% IN PORTA NUOVA, 98% OCCUPANCY
- 2 LIMITED EXPOSURE TO SEGMENTS MOST AFFECTED BY LOCK-DOWN**
HOTEL & RETAIL REPRESENT 5% OF RENT ROLL
- 3 SOLID AND DIVERSIFIED TENANT BASE**
11 OF TOP 15 TENANTS ARE LARGE MULTINATIONAL CORPORATIONS
- 4 SUSTAINABLE LEVERAGE AND AMPLE LIQUIDITY**
39% LTV, €43M OF CASH ON BALANCE SHEET, NO SIGNIFICANT MATURITIES BEFORE 2022
- 5 LONG DURATION OF LEASE AGREEMENTS**
WALT OF 4.9 YEARS, NO MATERIAL EXPIRY IN 2020
- 6 DEVELOPMENT PROJECT FULLY DE-RISKED**
ONLY ACTIVE DEVELOPMENT SITE (CORSO COMO PLACE) 95% PRE-LET
- 7 HIGH SUSTAINABILITY PROFILE**
65% OF PORTFOLIO CERTIFIED, PORTA NUOVA CERTIFICATION IN PROGRESS

INCOME STATEMENT



€M	H1 2020	H1 2019	Δ Y-Y (%)	Δ Y-Y	2019	2018	2017
Rents	22.2	17.8	24.8%	4.4	37.3	36.3	34.2
Net real estate operating expenses	(2.0)	(1.9)	7.2%	(0.1)	(3.9)	(4.0)	(3.7)
NOI	20.2	16.0	26.8%	4.3	33.4	32.3	30.5
NOI margin (%)	91.0%	89.5%	1.5 p.p.	n.m.	89.6%	89.1%	89.1%
Transaction gains / losses	(0.1)	0.0	n.m.	(0.1)	0.0	5.6	0.0
G&A	(4.2)	(4.4)	(5.1%)	0.2	(8.7)	(8.6)	(8.0)
G&A / Rents (%)	18.7%	24.6%	(5.9) p.p.	n.m.	23.4%	23.7%	23.3%
Other expenses	(0.1)	(0.1)	n.m.	(0.0)	(0.2)	(2.4)	(0.1)
Non-recurring general expenses	(0.3)	(0.4)	n.m.	(0.1)	(1.1)	(1.9)	(0.9)
EBITDA	15.5	11.2	39.4%	4.3	23.5	25.0	21.6
EBITDA Margin (%)	69.9%	62.6%	7.3 p.p.	n.m.	62.8%	60.6%¹	63.1%
Net depreciation	(0.2)	(0.1)	n.m.	(0.1)	(0.3)	(1.2)	(0.0)
Net movement in fair value	(7.7)	6.1	n.m.	(13.8)	10.5	28.3	15.3
EBIT	7.6	17.2	n.m.	(9.6)	33.7	52.2	36.9
Financial income	0.2	0.0	n.m.	0.2	0.3	0.0	0.5
Other Income / expenses	1.7	1.5	10.6%	0.2	10.4	2.4	0.0
Recurring financial expenses	(4.0)	(3.5)	13.8%	(0.5)	(7.0)	(6.3)	(6.8)
Non-recurring financial expenses	(0.3)	(2.6)	n.m.	2.3	(2.7)	0.0	0.0
Profit before taxation	5.3	12.7	n.m.	(7.4)	34.7	48.3	30.7
Income tax	-	-	n.m.	0.0	0.0	0.0	0.0
Profit for the period after taxation	5.3	12.7	n.m.	(7.4)	34.7	48.3	30.7
Minorities	(1.7)	0.9	n.m.	(2.6)	(2.7)	(2.0)	(1.8)
Profit attributable to COIMA RES	3.6	13.6	(73.7)%	(10.0)	32.0	46.3	28.9
EPRA adjustments	5.3	(6.3)	n.m.	11.5	(18.0)	(31.2)	(13.6)
EPRA Earnings	8.8	7.3	21.2%	1.5	14.0	15.1	15.3
EPRA Earnings per share (€)	0.24	0.20	20.8%	0.04	0.39	0.42	0.42
FFO	11.6	5.1	n.m.	6.5	14.1	22.0	15.3
FFO adjustments	0.5	2.9	n.m.	(2.4)	3.6	(4.4)	1.5
Recurring FFO	12.1	8.0	50.4%	4.1	17.6	17.7	16.8
Recurring FFO per share (€)	0.33	0.22	50.0%	0.11	0.49	0.49	0.47

BALANCE SHEET



€M	JUN-20	DEC-19	Δ	JUN-20 ¹
Investment properties	761.1	767.7	(6.6)	689.7
Other assets	5.7	8.1	(2.4)	1.8
Investments (equity method)	38.1	33.7	4.5	1.6
Total LT assets	805.0	809.5	(4.6)	693.0
Trade receivables	14.3	10.0	4.3	11.7
Other assets	1.6	0.0	1.6	1.6
Cash	42.5	42.7	(0.2)	38.7
Total current assets	58.4	52.7	5.8	52.0
Held for sale assets	10.4	23.5	(13.1)	10.4
Total assets	873.8	885.7	(11.9)	755.4
Debt	316.5	340.2	(23.8)	275.0
Provisions	0.5	0.4	0.0	0.5
Other liabilities	4.2	4.2	(0.0)	4.2
Trade payables	14.7	13.4	1.3	13.4
Current financial debt	29.4	16.1	13.3	25.7
Total liabilities	365.2	374.4	(9.2)	318.7
Minorities	71.9	71.2	0.7	0.0
NAV	436.7	440.1	(3.4)	436.7
LTV	39.0%	38.8%	0.2 p.p.	37.0%



CASH FLOW



€M	H1 2020	H1 2019	Δ	2019	2018	2017
Profit (loss) for the period	5.3	12.7	(7.4)	34.7	48.3	30.7
Non cash items adjustments	7.0	(6.4)	13.4	(19.2)	(27.3)	(14.4)
Changes in working capital	(3.1)	(2.4)	(0.7)	(1.1)	0.6	3.6
Net cash flows generated (absorbed) from operating activities	9.1	3.8	5.3	14.3	21.6	19.9
Investment activities						
(Acquisition) / disposal of real estate property	12.0	0.2	11.9	1.0	18.2	(105.1)
(Acquisition) / disposal of other tangible and intangible assets	(0.1)	(0.1)	0.0	(0.1)	(0.1)	(0.4)
(Acquisition) / disposal of other non-current assets	0.0	0.0	0.0	0.0	0.0	38.0
(Acquisition) / disposal of financial assets	0.6	(0.0)	0.6	0.0	1.4	(1.5)
Acquisition of subsidiaries	0.0	0.0	0.0	(105.1)	0.0	0.0
Acquisition of associated companies	(2.8)	(1.3)	(1.5)	(3.5)	(2.2)	(0.6)
Net cash flows generated (absorbed) from investment activities	9.8	(1.2)	11.0	(107.7)	17.4	(69.6)
Financing activities						
Shareholders' contributions / (Dividend payment)	(7.2)	(7.2)	0.0	(10.8)	(10.1)	(7.3)
Increase / (decrease) in bank borrowings	(11.0)	(4.2)	(6.7)	16.6	28.1	(27.3)
Other change in financing activities	(1.0)	43.6	(44.6)	48.1	(1.8)	(1.7)
Net cash flows generated (absorbed) from financing activities	(19.1)	32.1	(51.3)	53.8	16.2	(36.3)
Net (decrease) / increase in cash equivalents and short-term deposits	(0.2)	34.8	(34.9)	(39.5)	55.2	(86.1)
Cash equivalents and short-term deposits (beginning of the period)	42.7	82.2	(39.5)	82.2	27.0	113.1
Cash equivalents and short-term deposits (end of the period)	42.5	117.0	(74.5)	42.7	82.2	27.0

DIVIDEND - OVERVIEW



■ DIVIDEND PER SHARE EVOLUTION (€)

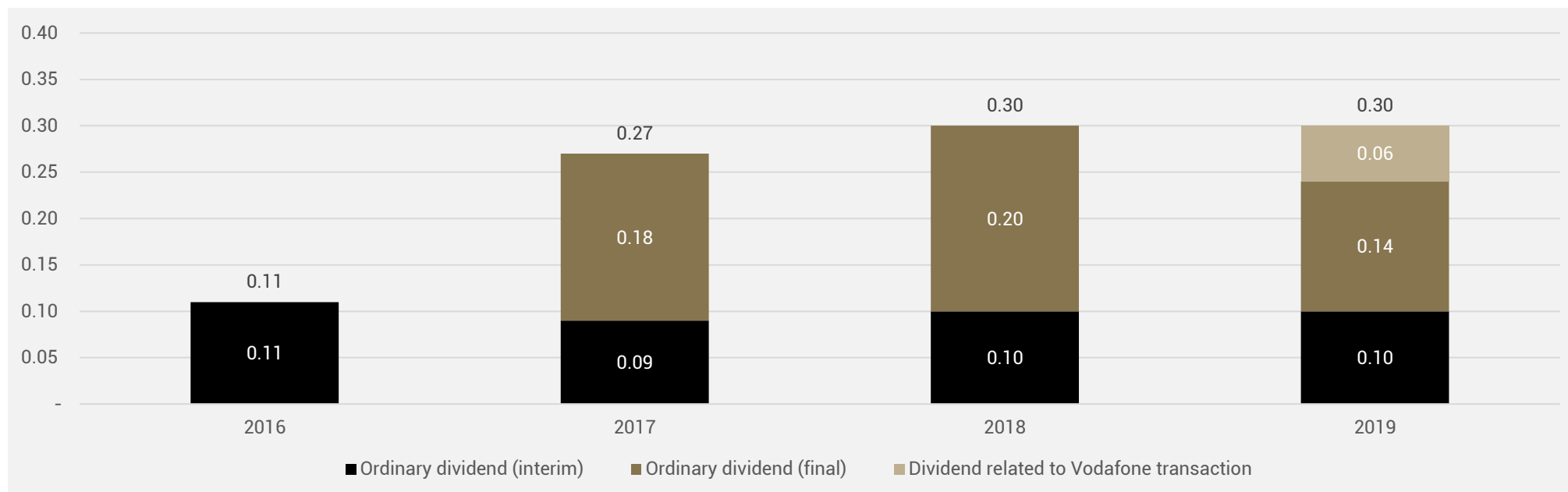

■ DIVIDEND RELATED TO VODAFONE TRANSACTION

- Vodafone transaction (2019) triggers a capital gain of €8.7m (i.e. €0.24 per share)
 - 50% of capital gain, i.e. c. €0.12 per share, to be distributed as extraordinary dividend within 2 years (in line with Italian REIT regime requirements)
- Approx. 50% (€0.06 per share) of total extraordinary dividend paid in June 2020
 - Reminder approx. 50% (c. €0.06 per share) payable in 2021

PORTFOLIO - DETAILS



	Milan Porta Nuova				Milan Other Districts				Non-office assets			
Data as of June 30 th , 2020	MICROSOFT	GIOIAOTTO	PAVILION	TOCQUE- VILLE	CORSO COMO PLACE	VODAFONE COMPLEX	MONTE ROSA	PHILIPS	DERUTA	DEUTSCHE BANK ¹	TELECOM PORTFOLIO	TOTAL
Location	Milan P. Nuova	Milan P. Nuova	Milan P. Nuova	Milan P. Nuova	Milan P. Nuova	Milan Lorenteggio	Milan CityLife	Milan Bicocca	Milan Lambrate	North & Centre of Italy	North & Centre of Italy	-
End use	Office	Office, Hotel	Office	Office	Office, Retail	Office	Office	Office	Office	Bank Branches	Telecom Assets	-
Strategy	Core	Core	Core	Core + / Value-add	Value-add	Core	Core +	Core	Core +	Core	Core	-
Ownership (pro-quota)	83.5%	88.2%	100.0%	100.0%	35.7%	50.0%	100.0%	78.3%	100.0%	100.0%	13.7%	-
Gross Asset Value (100% of asset)	€99.0m	€82.6m	€72.7m	€59.1m	€184.5m	€211.0m	€60.6m	€62.5m	€45.8m	€67.8m	€57.2m	
Gross Asset Value (pro-quota)	€82.6m	€72.8m	€72.7m	€59.1m	€65.9m	€105.5m	€60.6m	€48.9m	€45.8m	€67.8m	€7.9m	€689.7m
WALT (years)	3.5	4.4	7.6	1.8	n.m.	6.6	3.4	6.2	1.5	6.6	12.4	4.9
Occupancy rate	100%	100%	100%	100%	n.m.	100%	90%	100%	100%	93%	100%	97.9%
Gross initial rent ²	€4.6m	€4.3m	€3.5m	€2.4m	n.m.	€14.1m	€3.7m	€3.9m	€3.6m	€3.9m	n.m.	€44.0m
EPRA net initial yield	4.2%	4.7%	4.6%	3.6%	n.m.	6.2%	5.0%	5.6%	7.2%	4.7%	6.4%	5.1%
EPRA topped-up net initial yield	4.2%	4.7%	4.6%	5.2%	n.m.	6.2%	5.0%	5.8%	7.2%	5.3%	6.4%	5.3%

Notes:

1) Pro-forma for Deutsche Bank branches disposals announced in November 2019 and not yet closed as of June 30th, 2020

2) Considering the Vodafone complex, Microsoft, Philips and Gioiaotto as 100% consolidated and not considering Corso Como Place and the Telecom Portfolio

PORTFOLIO - MILAN OFFICE ASSETS



PORTA NUOVA



OTHER DISTRICTS

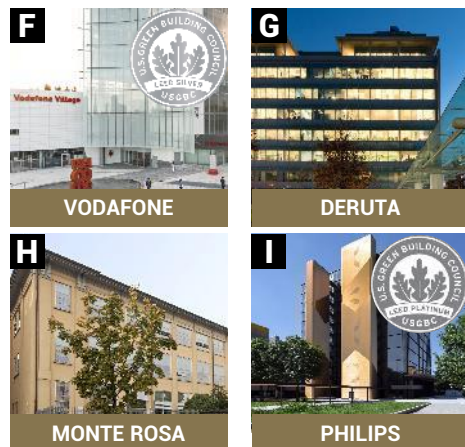

COIMARES

Airport Malpensa

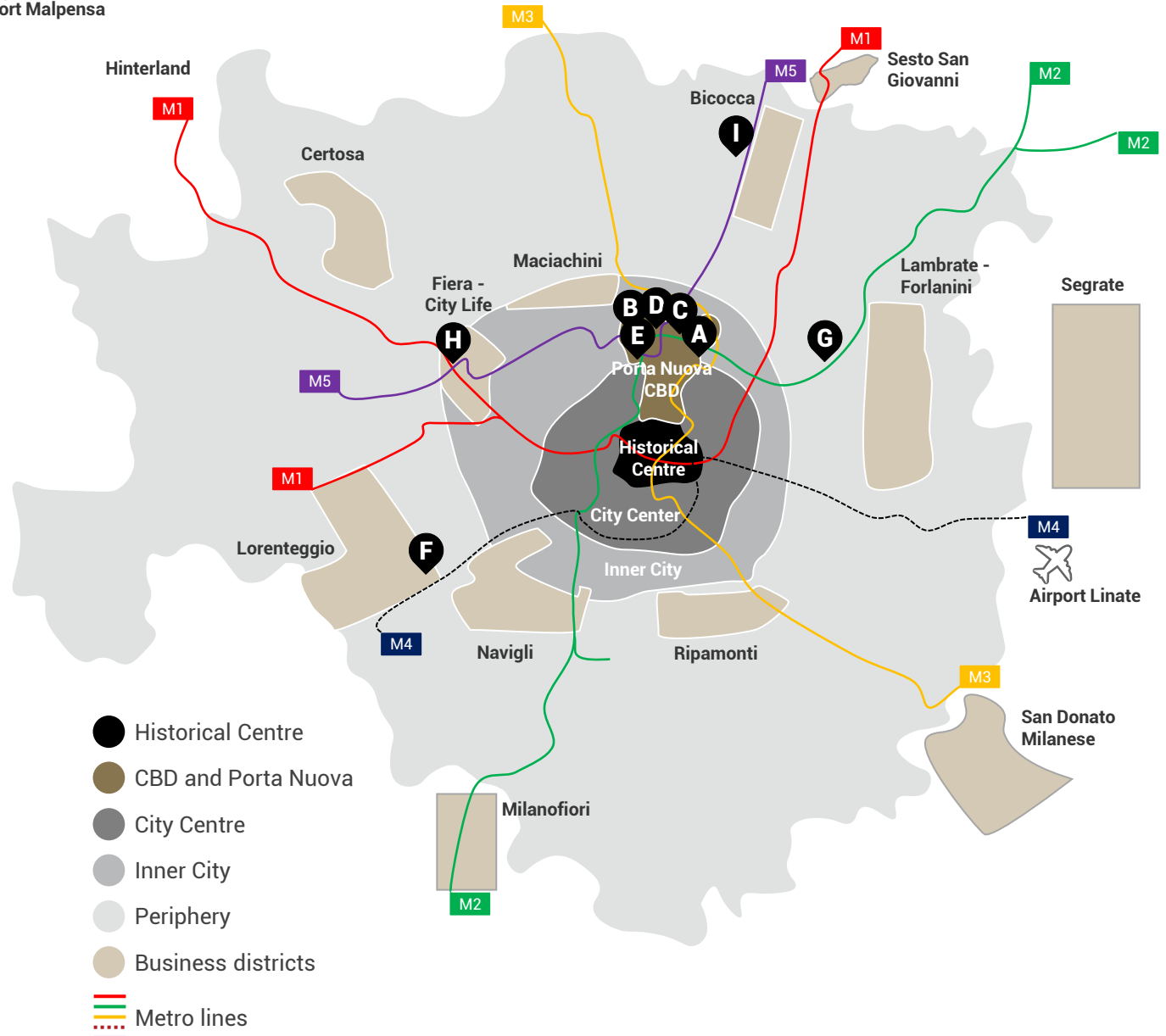

PORTFOLIO - WALT PROFILE



Core profile, development portion already pre-let, no additional development sites to be activated in 2020

OVERVIEW

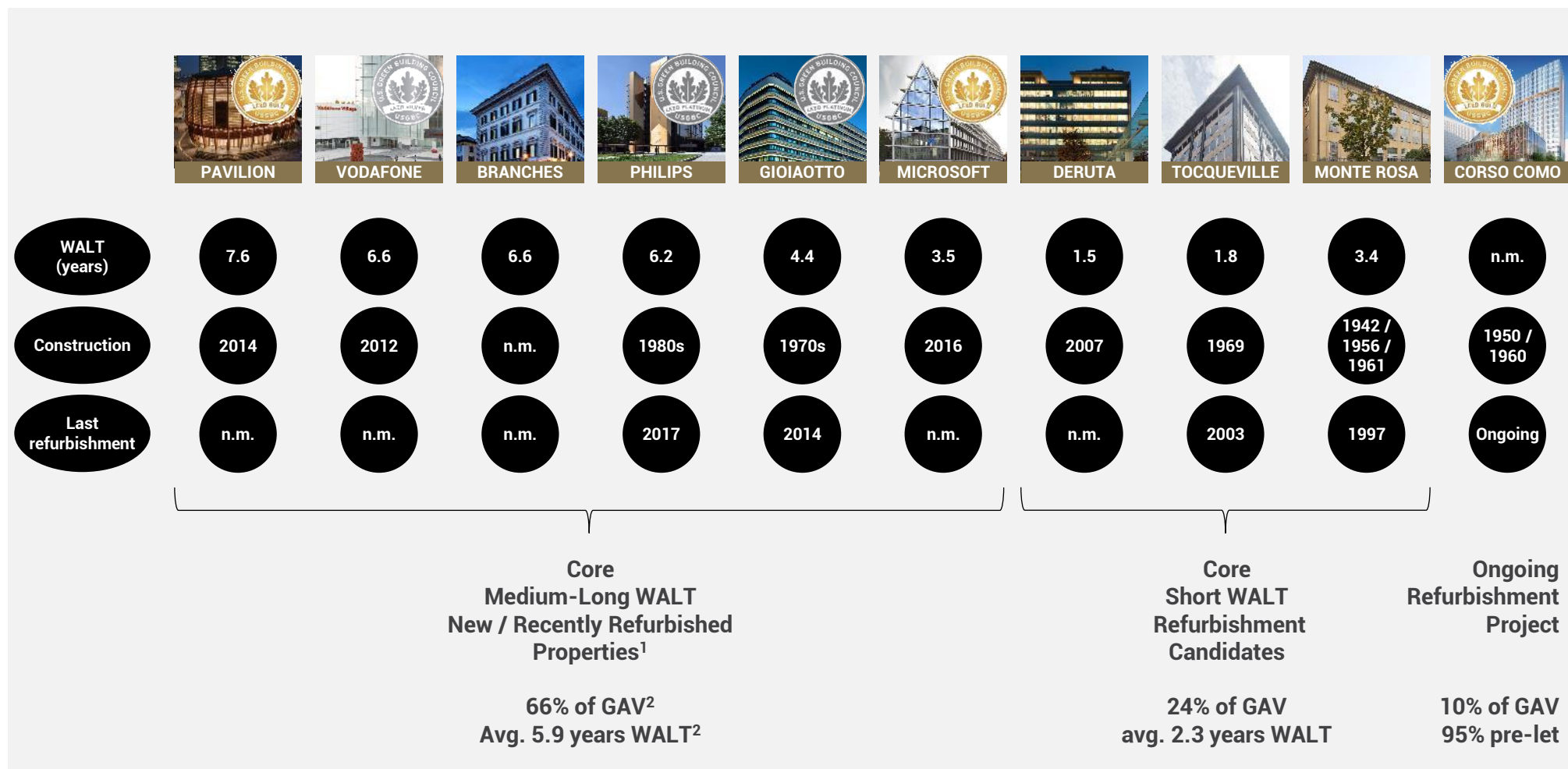

Note:

- 1) Not considering bank branches
- 2) Including also the Telecom Portfolio

OUR JOURNEY SINCE IPO - KEY DATA POINTS



Actively refocused the portfolio towards the most liquid asset class (offices) and towards a more resilient business district (Porta Nuova) whilst increasing the upside potential and decreasing risk profile & concentration

KEY PORTFOLIO METRICS (% , pro-quota basis)

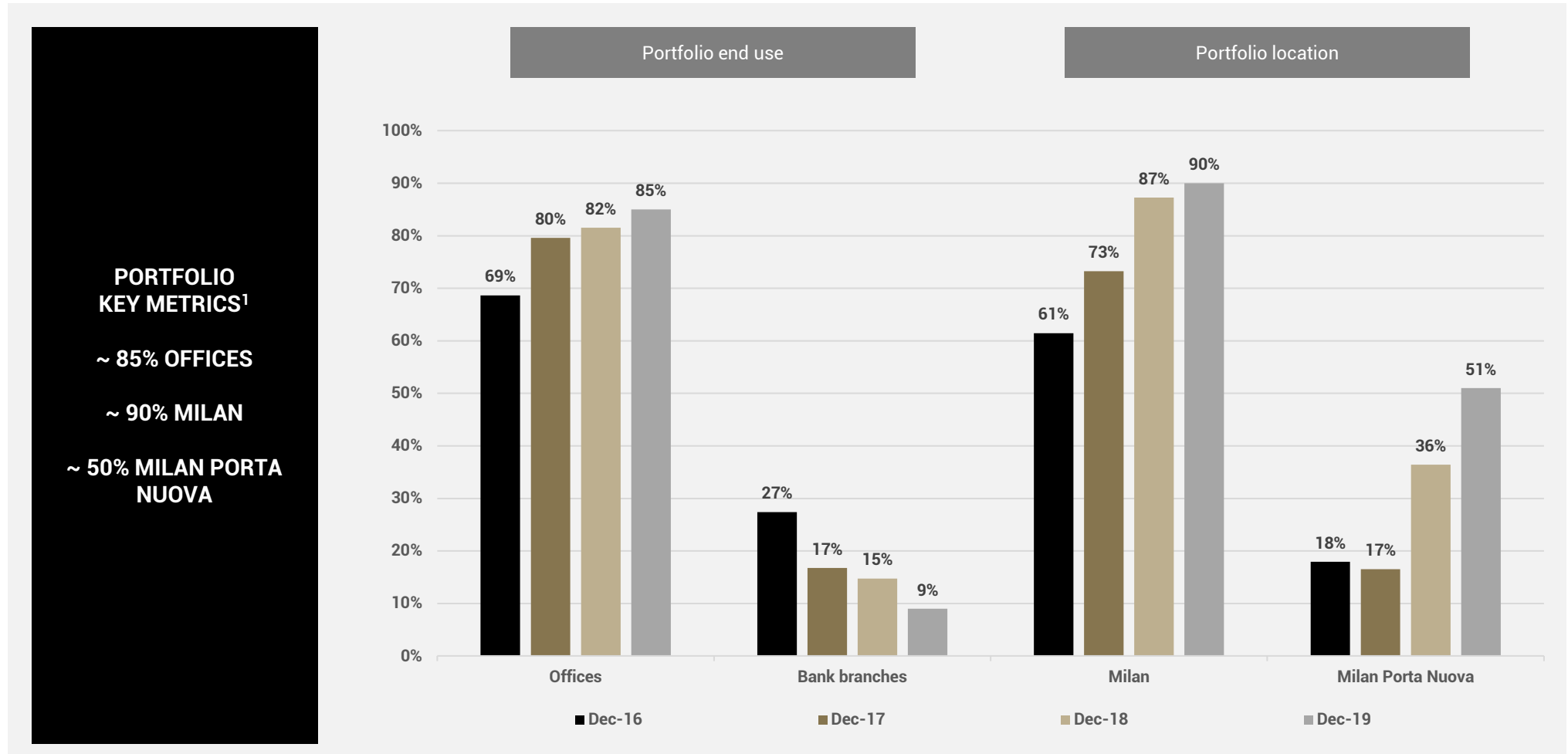

Note:
 1) Data as of December 31st, 2019, pro forma for €24m bank branches disposals announced in November 2019 and not yet closed as of December 31st, 2019

PORTFOLIO ROTATION - UPDATE



Rotated 28% of the acquired portfolio since IPO

Sold assets at a blended premium of 5.0% to acquisition price (or at a 7.6% premium considering only office assets)

OVERVIEW OF PORTFOLIO ROTATION SINCE IPO (€m, pro-quota basis)

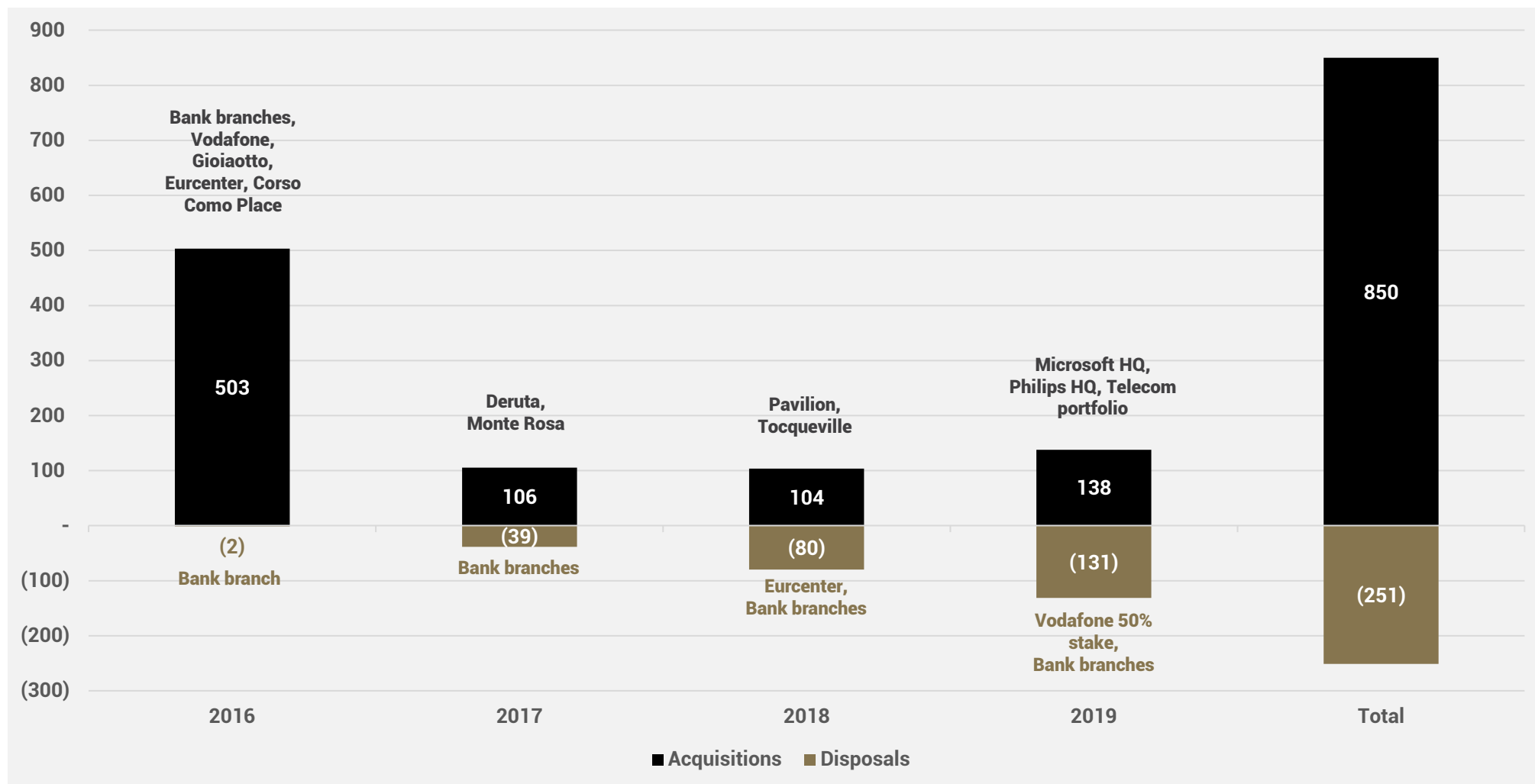



A sizeable and iconic newly-built property let to a blue chip tenant in the fast growing Milan Porta Nuova district

KEY DATA

■ Ownership (look through)	83.5%
■ Construction Year	2016
■ Last Refurbishment Year	n.a.
■ Acquisition Year by COIMA RES	2019
■ Asset Type	Office
■ Tenant	Microsoft
■ Surface	10,795 sqm (100% of asset)
■ Fair Value	€99.0m (100% of asset)
■ Gross Initial Rent	€4.6m (100% of asset)
■ EPRA Net Initial Yield	4.2%
■ EPRA Topped-up NIY	4.2%
■ WALT	3.5 years
■ EPRA Occupancy Rate	100%
■ Certification	LEED Gold
■ Architect	Herzog & de Meuron

PICTURES





A LEED certified property in Milan Porta Nuova with rental growth potential

KEY DATA

■ Ownership (look through)	88.2%
■ Construction Year	1970s
■ Last Refurbishment Year	2014
■ Acquisition Year by COIMA RES	2016
■ Asset Type	Hotel / Office
■ Tenants	NH Hotel / Angelini / QBE / etc
■ Surface	14,545 sqm (100% of asset)
■ Fair Value	€82.6m (100% of asset)
■ Gross Initial Rent	€4.3m (100% of asset)
■ EPRA Net Initial Yield	4.7%
■ EPRA Topped-up NIY	4.7%
■ WALT	4.4 years
■ EPRA Occupancy Rate	100%
■ Certification	LEED Platinum
■ Architect	Park Associati

PICTURES





Marginal downward revision of fair value of hotel portion and office portion of the asset in H1 2020

ASSET OVERVIEW

As of Jun-20	Office	Hotel	Total
Gross Asset Value	€53.6m (65% of tot)	€29.0m (35% of tot)	€82.6m
Surface (NRA)	6,657 sqm (46% of tot)	7,888 sqm (54% of tot)	14,545 sqm
Gross Rent (stabilised)	€2.8m (65% of tot)	€1.5m (35% of tot)	€4.3m
Gross Rent (stabilised) / sqm	c. €430 / sqm	c. €190 / sqm	c. €300 / sqm
Gross Yield (stabilised)	5.2%	5.2%	5.2%

VALUATION ADJUSTMENT (€m)

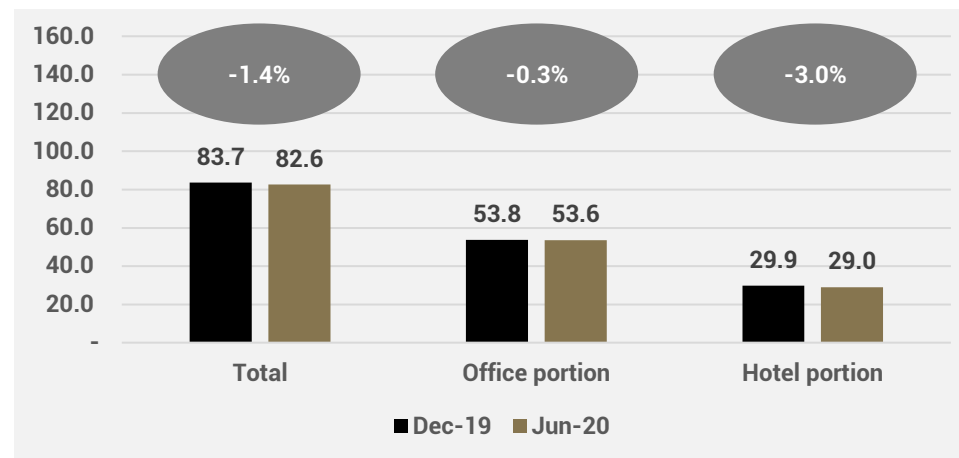

ASSET BREAKDOWN

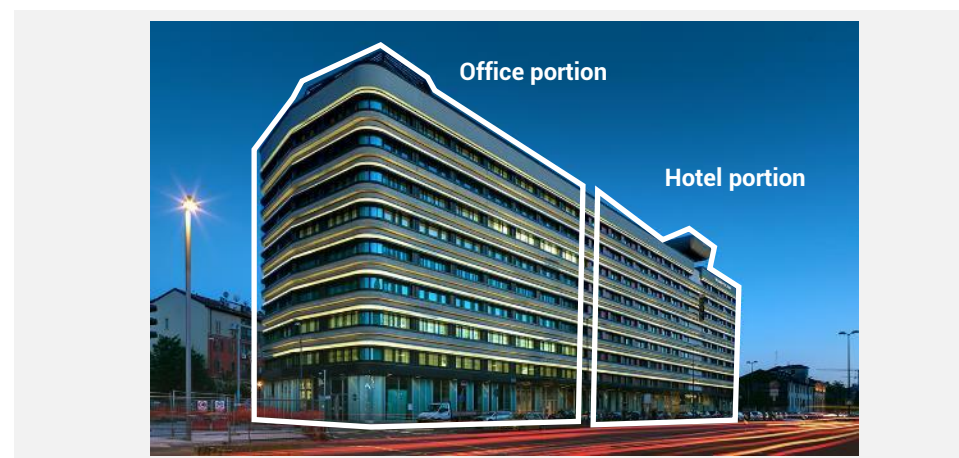

PAVILION



A unique property in Milan Porta Nuova leased to a blue chip tenant

KEY DATA

■ Ownership	100.0%
■ Construction Year	2014
■ Refurbishment Year	n.a.
■ Acquisition Year by COIMA RES	2018
■ Asset Type	Office
■ Tenant	IBM
■ Surface	3,576 sqm
■ Fair Value	€72.7m
■ Gross Initial Rent	€3.5m
■ EPRA Net Initial Yield	4.6%
■ EPRA Topped-up NIY	4.6%
■ WALT	7.6 years
■ EPRA Occupancy Rate	100%
■ Certification	LEED Gold
■ Architect	Michele De Lucchi

PICTURES



TOCQUEVILLE



An under-rented and strategically located property in Milan Porta Nuova with growth potential upon refurbishment

KEY DATA

■ Ownership	100.0%
■ Construction Year	1969
■ Last Refurbishment Year	2003
■ Acquisition Year by COIMA RES	2018
■ Asset Type	Office
■ Tenant	Sisal
■ Surface	9,604 sqm
■ Fair Value	€59.1m
■ Gross Initial Rent	€2.4m
■ EPRA Net Initial Yield	3.6%
■ EPRA Topped-up NIY	5.2%
■ WALT	1.8 years
■ EPRA Occupancy Rate	100%
■ Certification	n.a.
■ Architect	n.a.

PICTURES



CORSO COMO PLACE



A “next generation” project in the heart of Porta Nuova

- Value-add project in the heart of Milan Porta Nuova
 - Joint venture¹ between COIMA RES and COIMA Opportunity Fund II

Total project cost of c. €169m

- Acquisition price of €89m
- Hard and soft capex of c. €60m
- Capitalised financing costs of c. €12m
- Other costs (including incentives) of c. €9m

Cutting edge sustainable and innovative technologies

- Award winning firm PLP Architecture leading the project
- Smart Building: > 5,000 monitoring sensors, cloud based analytics
- Approx. 65% of energy use from renewable sources (NZEB)
- Targeting LEED Gold, WELL Gold and Cradle to Cradle certifications

Place-making

- Creation of a new public space (c. 2,500 sqm)
- ~ €1m to be invested in improving c. 6,000 sqm of public area
- Seamless integration of streets connecting to Corso Como & Porta Nuova

- **Building A** (high-rise office tower, 16,000 sqm GBA)
 - existing building, hard refurbishment
 - 100% pre-let to Accenture
- **Building B** (low-rise office tower, 6,200 sqm GBA)
 - existing building, extraordinary maintenance works only
 - currently 100% leased
- **Building C** (new office / retail low-rise, 4,800 sqm GBA)
 - new building (partially replacing underground parking)
 - demolish and rebuild existing underground parking
 - develop new office with ground floor retail
 - 80% pre-let to Bending Spoons

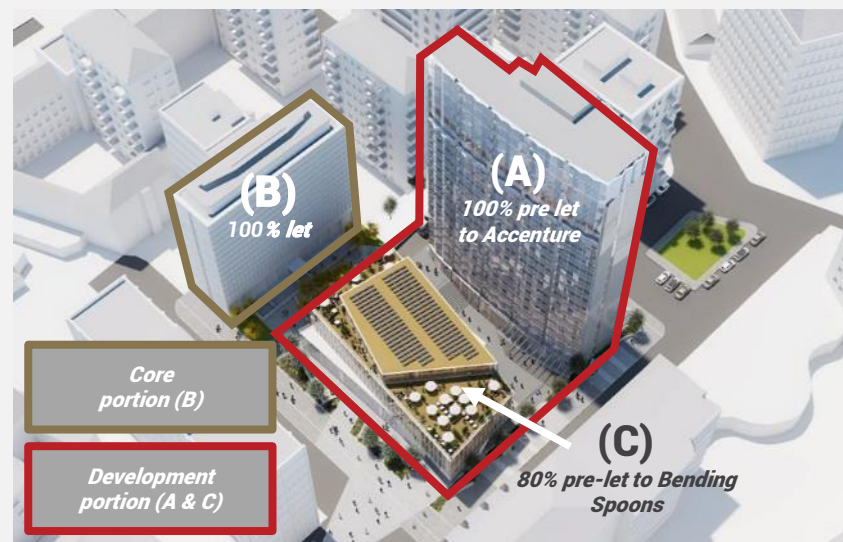

LEED
Gold



Cradle
to
Cradle



WELL
Gold



Near Zero
Energy
Building

VODAFONE COMPLEX



A LEED certified property in the Milan Lorenteggio district serving as Italian HQ for Vodafone

KEY DATA

■ Ownership	50.0%
■ Construction Year	2012
■ Refurbishment Year	n.a.
■ Acquisition Year by COIMA RES	2016
■ Asset Type	Office
■ Tenant	Vodafone
■ Surface	42,039 sqm (100% of asset)
■ Fair Value	€211.0m (100% of asset)
■ Gross Initial Rent	€14.1m (100% of asset)
■ EPRA Net Initial Yield	6.2%
■ EPRA Topped-up NIY	6.2%
■ WALT	6.6 years
■ EPRA Occupancy Rate	100%
■ Certification	LEED Silver
■ Architect	Gantes & Marini

PICTURES



MONTE ROSA



An under-rented office building in the Milan City Life-Lotto district well connected with public transport

KEY DATA

■ Ownership	100.0%
■ Construction Year	1942 / 1956 / 1961
■ Last Refurbishment Year	1997
■ Acquisition Year by COIMA RES	2017
■ Asset Type	Office
■ Main Tenants	Techint / PwC
■ Surface	19,539 sqm
■ Fair Value	€60.6m
■ Gross Initial Rent	€3.7m
■ EPRA Net Initial Yield	5.0%
■ EPRA Topped-up NIY	5.0%
■ WALT	3.4 years
■ EPRA Occupancy Rate	90%
■ Certification	n.a.
■ Architect	n.a.

PICTURES



MONTE ROSA



Evaluating refurbishment / redevelopment scenarios for Monte Rosa, in the process of selecting architects

MAIN EVENTS

- Asset acquired in 2017 from Techint as a sale and lease-back
 - Techint is long term tenant (residual WALT of 6.3 years)
 - PwC expected to vacate property in 2021
- Potential to upgrade the asset in 2021-2022
 - Buildings F, G and M could be refurbished / redeveloped
 - Intensity of refurbishment / redevelopment under review

ARCHITECTURAL FIRMS SELECTION PROCESS

- Preselection involved 41 invitations to architectural firms
 - mix of Italian and International firms
 - 24 responses received
 - 6 firms shortlisted
- Official competition launched on April 1st, 2020
 - In the process of selecting the winning firm

TENANCY BREAKDOWN

Buildings	NRA (sqm)	Tenants)	WALT (years)	Gross passing rent (€m)
H	5,563 (40% of tot)	Techint & Others	6.3	€1.8m
F	3,294 (25% of tot)	PwC	0.7	€1.0m
G	2,091 (15% of tot)	PwC	0.6	€0.2m
M	3,046 (22% of tot)	PwC	0.5	€0.6m
Total	13,994	-	3.4	€3.7m

ASSET OVERVIEW



MONTE ROSA



Currently studying various refurbishment scenarios for Monte Rosa, with different capex intensity

■ SCENARIO 1

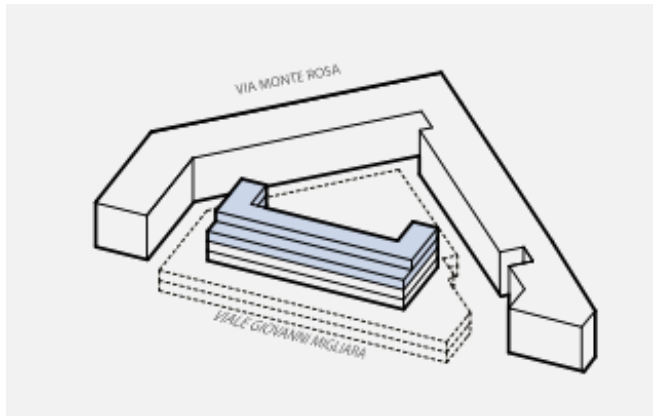

■ SCENARIO 2

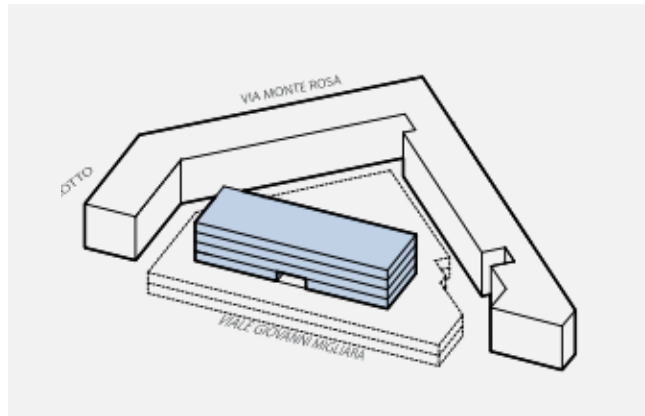

■ SCENARIO 3

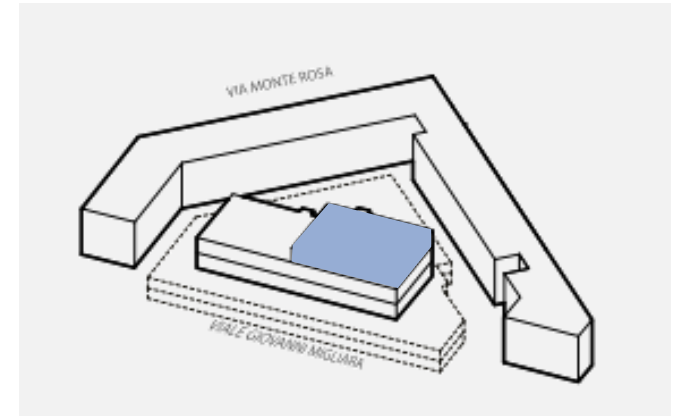

■ SCENARIO 4

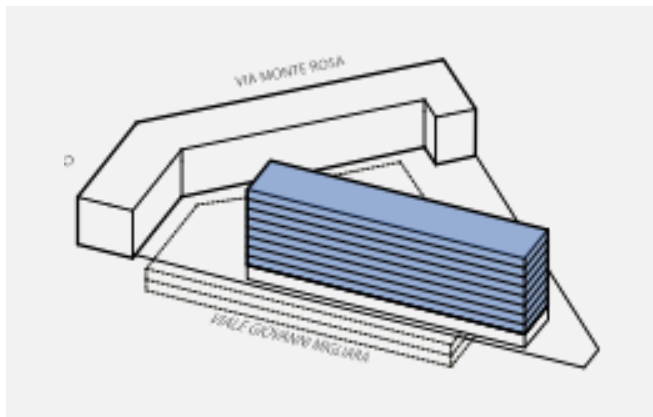

■ SCENARIO 5

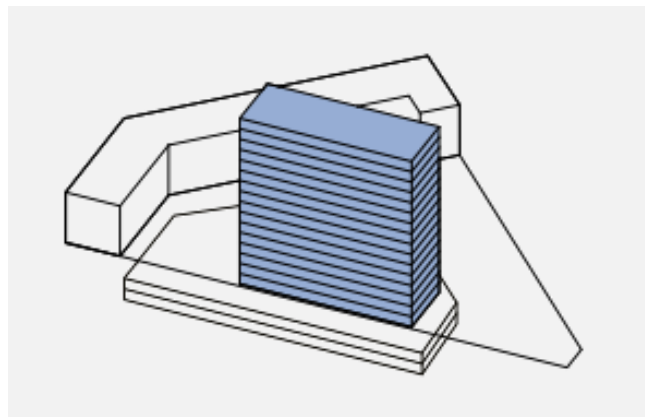

■ SCENARIO 6

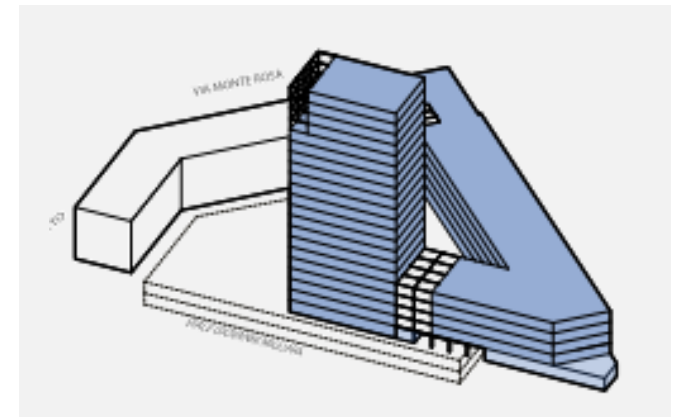



A high quality refurbished property in the consolidated and highly liquid district of Milan Bicocca

KEY DATA

■ Ownership (look through)	78.3%
■ Construction Year	1980's
■ Last Refurbishment Year	2017
■ Acquisition Year by COIMA RES	2019
■ Asset Type	Office
■ Main Tenant	Philips (54% of NRA)
■ Surface	17,453 sqm (100% of asset)
■ Fair Value	€62.5m (100% of asset)
■ Gross Initial Rent	€3.9m (100% of asset)
■ EPRA Net Initial Yield	5.6%
■ EPRA Topped-up NIY	5.8%
■ WALT	6.2 years
■ EPRA Occupancy Rate	100%
■ Certification	LEED Platinum
■ Architect	Alessandro Scandurra

PICTURES

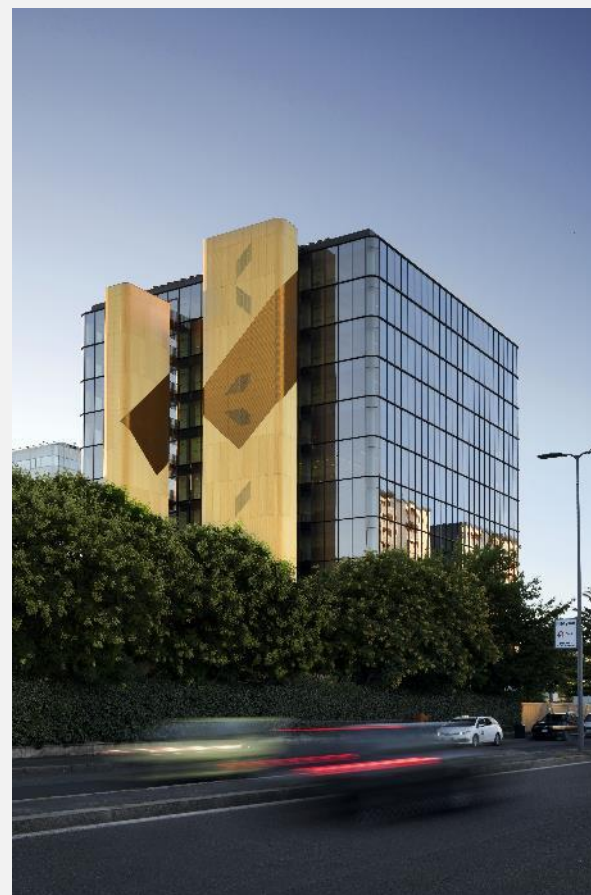



A modern office building in the Milan Lambrate district well connected with public transportation

KEY DATA

■ Ownership	100.0%
■ Construction Year	2007
■ Refurbishment Year	n.a.
■ Acquisition Year by COIMA RES	2017
■ Asset Type	Office
■ Tenant	BNL (BNP Paribas)
■ Surface	26,012 sqm
■ Fair Value	€45.8m
■ Gross Initial Rent	€3.6m
■ EPRA Net Initial Yield	7.2%
■ EPRA Topped-up NIY	7.2%
■ WALT	1.5 years
■ EPRA Occupancy Rate	100%
■ Certification	n.a.
■ Architect	n.a.

PICTURES

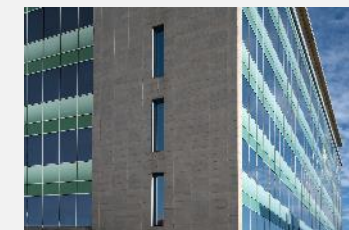

BANK BRANCHES - DISPOSALS SINCE IPO



Sold c. 48% of initial IPO portfolio (€66.3m) at a valuation in line with IPO contribution value

Remaining portfolio concentrated in Lombardy (52%), Rome (13%) and other regions in the North & Centre of Italy (35%)

PORTFOLIO AT IPO (MAY-16)

#: 96 branches
Book Value @ IPO: €140.1m

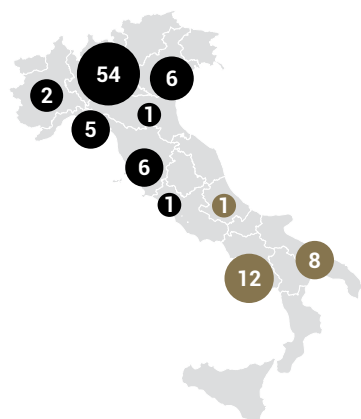

DISPOSALS (SINCE IPO)

#: 38 branches
Sale Price: €66.3m
Delta vs Book Value @ IPO: 1.6% discount



North & Centre
#: 17 branches
Sale Price: €28.3m (43% of total)

South
#: 21 branches
Sale Price: €38.0m (57% of total)

REMAINING PORTFOLIO

#: 58 branches
Book Value @ Jun-20: €67.8m



Breakdown
Lombardy ex Milan 42% of total
Rome 13% of total (single bank branch)
Milan 10% of total
Piedmont 10% of total
Veneto 9% of total
Tuscany, Liguria, Emilia Romagna 16% of total

BANK BRANCHES - RESIDUAL EXPOSURE



Bank branches exposure represents less than 10% of total portfolio (on a pro-quota basis)

BOOK VALUE DISTRIBUTION BY BRANCH (€m)

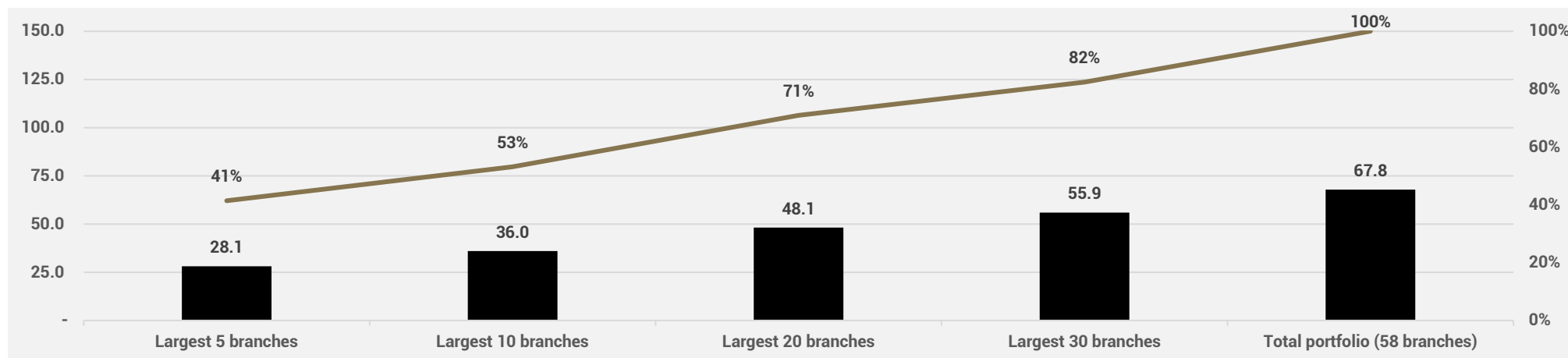

BOOK VALUE DISTRIBUTION BY REGION (%)

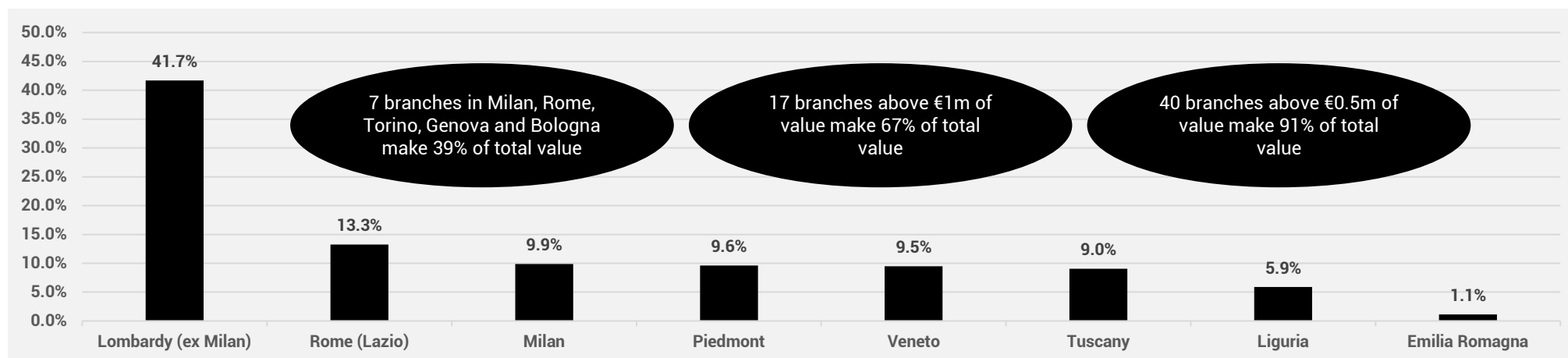

Key Highlights
Manfredi Catella, CEO

Financial Results
Fulvio Di Gilio, CFO

Portfolio & Asset Management
Matteo Ravà, Head of Asset Management

Market Outlook
Gabriele Bonfiglioli, Head of Investments

Closing Remarks
Manfredi Catella, CEO

Appendix: Financials & Portfolio
Appendix: Governance & Sustainability

COIMARES



COIMA RES - BEST IN CLASS GOVERNANCE



Chairman
(non executive)

Massimo Capuano
former CEO
Italian Stock Exchange
former deputy CEO
London Stock Exchange

Manfredi Catella
Founder and CEO
COIMA

Feras Abdulaziz Al Naama
Qatar Holding

Olivier Elamine
Founder and CEO
alstria office

Luciano Gabriel
Chairman (and former CEO & CFO)
PSP Swiss Properties

Board of Directors

7 of 9 independent
4 of 9 with real estate experience
3 of 9 international

Ariela Caglio
Professor
Bocconi University

Alessandra Stabilini
Lawyer
NCTM

Antonella Centra
General Counsel
Gucci

Paola Bruno
Entrepreneur
Augmented Finance

Independent
(Italian and with
corporate finance,
regulatory and legal
expertise)

Independent
(international and
with real estate
expertise)

Investment Committee
Manfredi Catella (Chairman)
Gabriele Bonfiglioli
Matteo Ravà
Feras Abdulaziz Al Naama
Luciano Gabriel
Michael Vauclair

Remuneration Committee
Alessandra Stabilini (Chairman)
Massimo Capuano
Olivier Elamine

Risk, Control & Related Parties Committee
Alessandra Stabilini (Chairman)
Luciano Gabriel
Paola Bruno

COIMA RES - STRUCTURE OVERVIEW

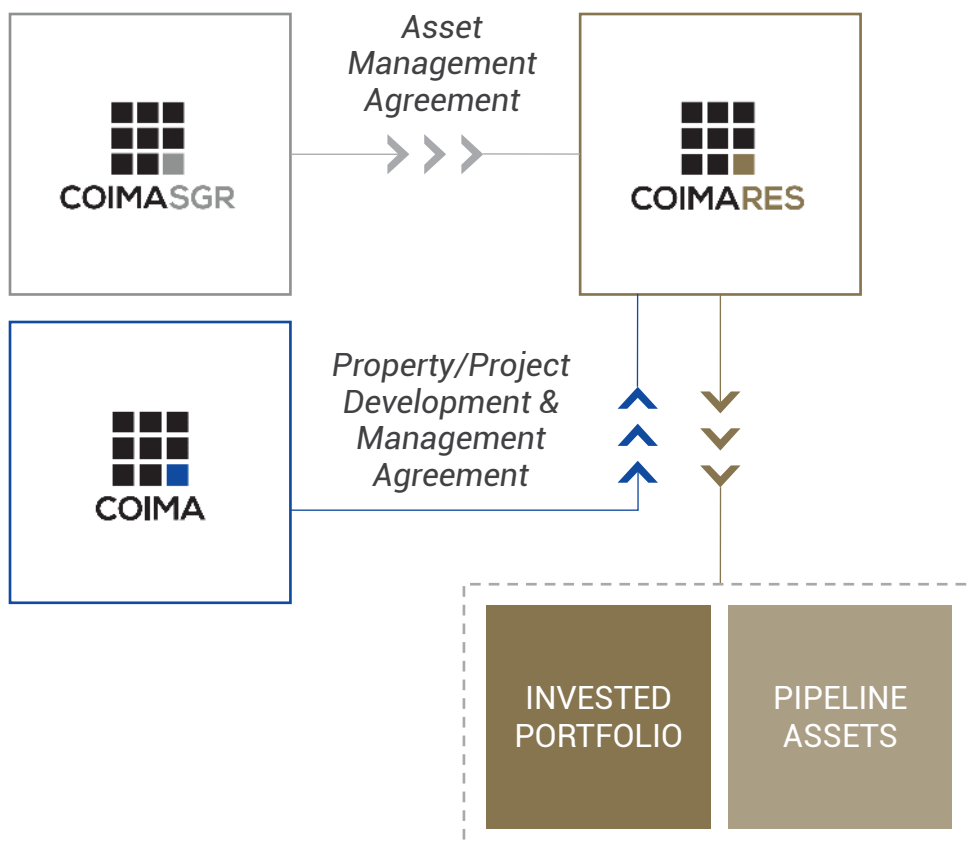

COIMA SGR COMPENSATION

BASE FEE

- COIMA SGR's compensation is based on NAV with a scale down mechanism:
 - 80 bps (of NAV \leq €1.0bn)
 - 60 bps (of NAV €1.0-1.5bn)
 - 50 bps (of NAV \geq €1.5bn)

PROMOTE

- COIMA SGR's (40%) and key managers' (60%) compensation is based on Total Return¹:
 - 10% above 8% Total Return¹
 - 20% over 10% Total Return¹
 - subject to High Watermark

COIMA SRL COMPENSATION

- COIMA Srl's compensation is based on international benchmark for comparable services
 - 1.0% of annual gross rents for mono-tenant buildings
 - 1.3% of annual gross rents for buildings with 2-4 tenants
 - 1.5% of annual gross rents for buildings with 5 tenants or more

CORPORATE STRUCTURE - OVERVIEW



OVERVIEW OF CORPORATE AND FINANCING STRUCTURE

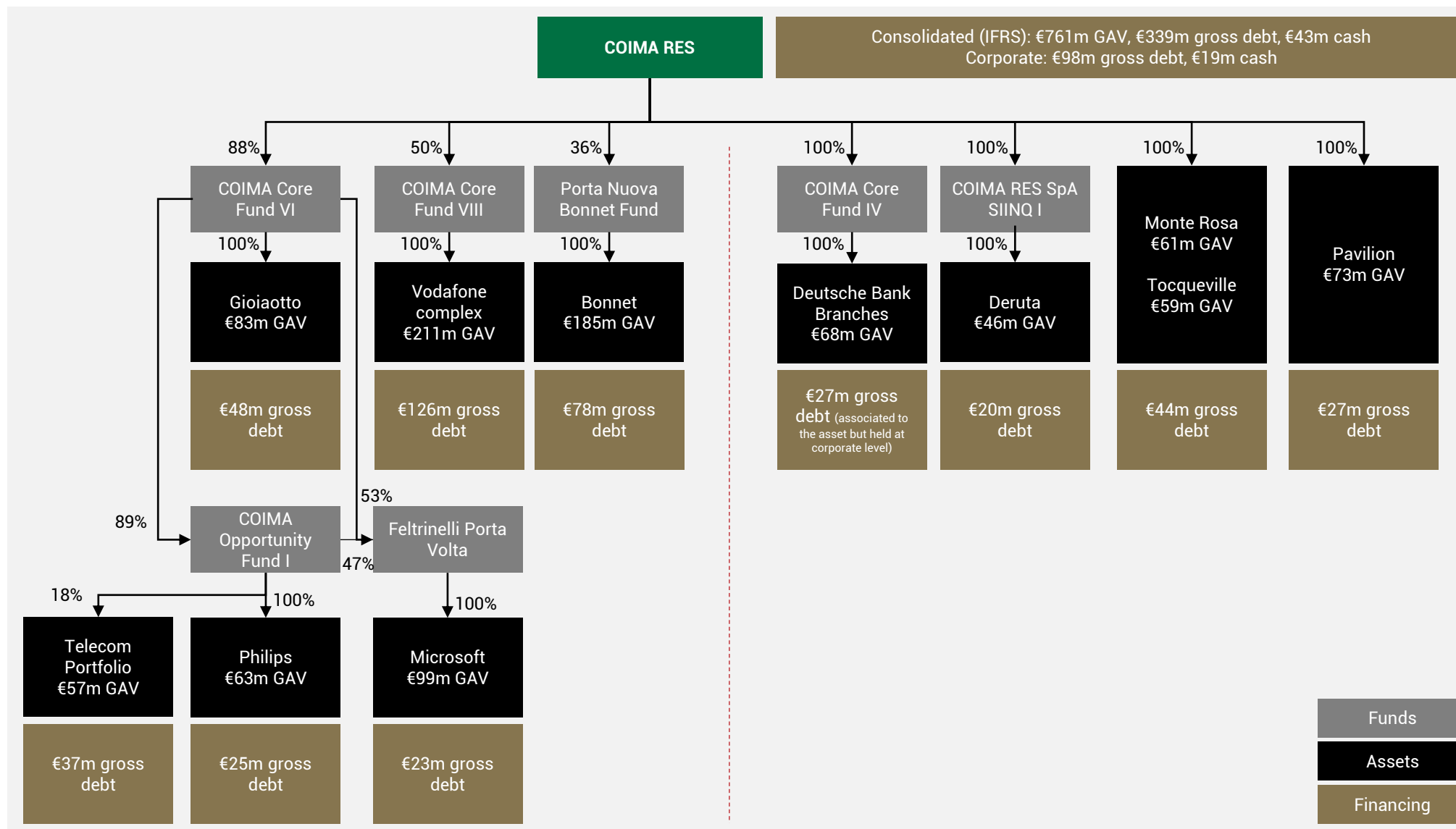

Note:

- 1)
- 2)

Data as of June 30th, 2020

Excluding €6.5m of debt related to the bank branches (due in 2023) which will be reimbursed in 2020 on the back of the disposal already announced

COIMA - IN HOUSE EXPERTISE ON ESG & INNOVATION

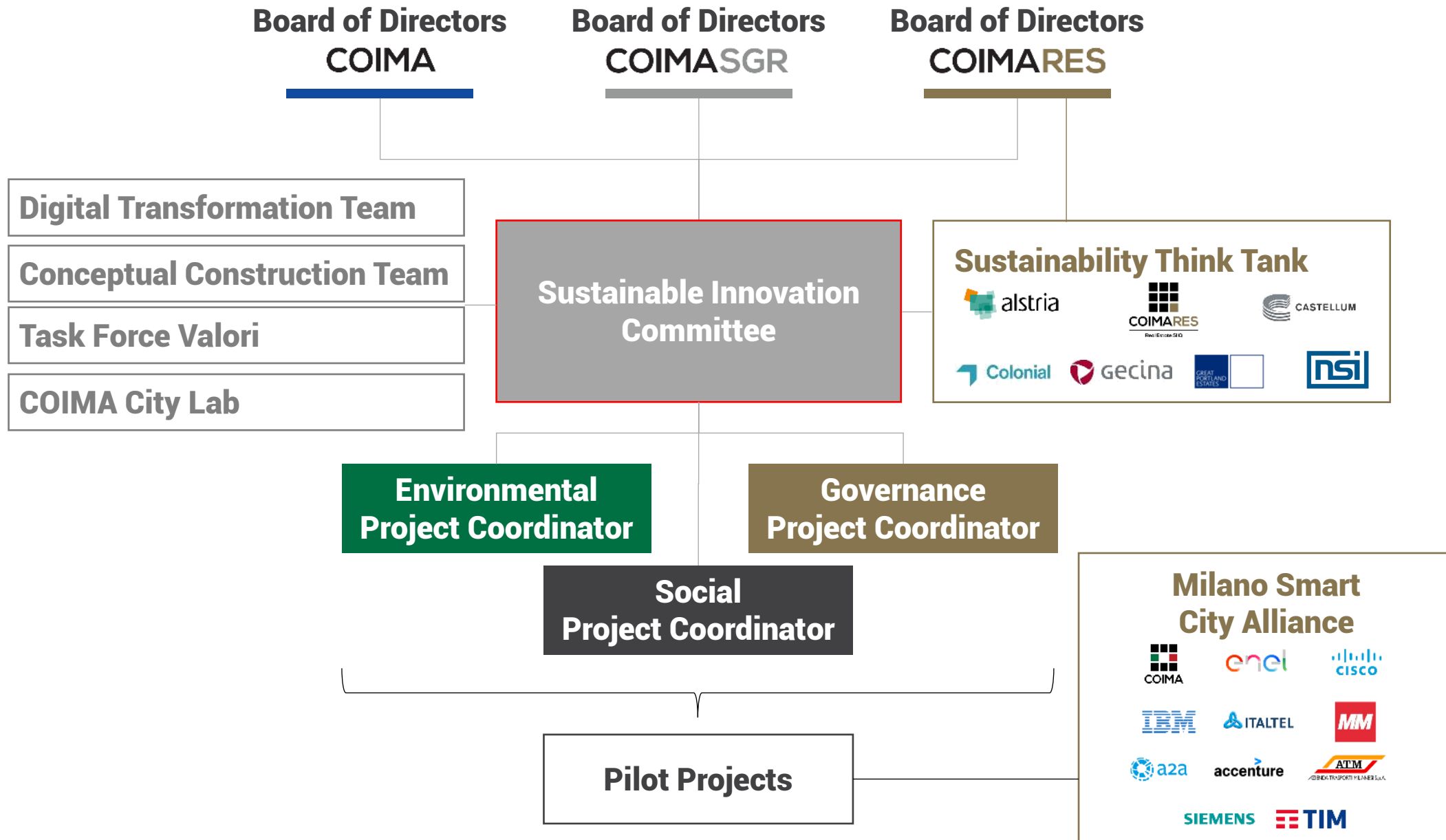

COIMA RES - SUSTAINABILITY & INNOVATION



Commitment to be best in class in terms of transparency, reporting, sustainability and innovation

■ EPRA GOLD AWARDS IN REPORTING

- COIMA RES received the “Gold Award” from the European Public Real Estate Association (EPRA) for its 2016, 2017 and 2018 Annual Report and Sustainability Report



■ THINK TANK ON SUSTAINABILITY AND INNOVATION

- COIMA RES part of a European Think Tank focused on sustainability and innovation with six other REITs



■ INCLUDED IN GPR IPCM SUSTAINABILITY INDEX

- COIMA RES was included in GPR IPCM LFSS Sustainable GRES Index since March 19th, 2018
- COIMA RES attained a particularly high score of 7.8 out of 10 in the Sustainability and ESG model which considers various factors including strategy, energy efficiency, management of climate change, water efficiency and the recognition of the strong commercial potential of proactively addressing environmental aspects
- COIMA RES is currently a top 25 company out of the 150 companies included in the GPR IPCM Sustainability Index

COIMA - ESG MILESTONES AND TIMELINE



- 1974** COIMA is created
- 2005** Porta Nuova (UniCredit Tower) first LEED Gold certified building in Italy
Creation of Fondazione Riccardo Catella
- 2015** COIMA publishes its first Sustainability Report
Bosco Verticale awarded as Best Tall Building globally
- 2016** COIMA creates the Sustainable Innovation Committee
- 2017** COIMA RES joins the Pan-European Think Tank on innovation & sustainability

- 2018** First public/private experience with BAM Biblioteca degli Alberi Milano
- 2019** Creation of COIMA City Lab
- 2020** COIMA receives the European Leadership Award on sustainability from the US Green Building Council.



PORTA NUOVA - SUSTAINABILITY MEANS RESILIENCE



World's first district redevelopment project to aim for dual LEED for Communities & WELL Community certification

Submitted application to achieve LEED for Communities and WELL Community certifications

Porta Nuova set to be the world's first district redevelopment project to obtain a double certification

Certifications analyse the social, environmental and economic aspects of the Porta Nuova

Part of Porta Nuova is also BAM (Biblioteca degli Alberi), Italy's first public park managed through a unique agreement between the Milan City Council, COIMA SGR and the Riccardo Catella Foundation



Other COIMA SGR awards

"Best Urban Regeneration Project - Porta Nuova" MIPIM (2018)

"Best Office & Business Development - Fondazione Feltrinelli & Microsoft House" MIPIM (2018)

"Best Tall Building Worldwide - Bosco Verticale" CTBUH (2015)

ENVIROMENTAL PERFORMANCE IN 2019 - OVERVIEW



Several actions were taken in 2019 on the properties to improve their environmental performance

■ MAIN IMPROVEMENT ACTIONS ON PORTFOLIO

**CARBON
INTENSITY**
0.072
tCO₂e / sqm

6%
**ESTIMATED
REDUCTION OF
ELECTRIC
ENERGY
CONSUMPTION
IN 2019
(LIKE FOR LIKE
BASIS)**

**ENERGY
INTENSITY**
264
kWh/sqm per year

7%
**ESTIMATED
REDUCTION OF
ENERGY
INTENSITY OF
THE PORTFOLIO
IN 2019
(LIKE FOR LIKE
BASIS)**

- **Monte Rosa**
 - Replacement of the garage lights with LED lamps (-46% consumption)
 - Maintenance of air conditioning systems and optimization of ignition times (-25% in energy consumption)
 - Restoration of the irrigation system with a 12% reduction in annual water consumption
 - Verification and optimisation of the MEP management system (BMS)
- **Vodafone complex**
 - Maintenance activity of the MEP system and of the external areas
 - Substitution of all neon lamps of the garage with LED lamps
- **Corso Como Place (Building B)**
 - Substitution of BMS System and optimisation
- **Deruta**
 - Audit and verification of the management of the property
 - Window foils replacement (façade) to improve the environmental comfort level and to reduce consumption
- **Tocqueville**
 - Maintenance activity of the MEP system and of the external areas
- **Gioiaotto**
 - Maintenance of the MEP system and of the external areas, verification and optimisation of the BMS system
 - Window foils replacement (top floor): improve environmental comfort + reduce air conditioning consumption
 - Installation of split systems "in serra" to improve the summer and winter climatization
 - Substitution of traditional lamps with LED lamps in underground floors and on staircases
 - Installation of a canalisation to improve the heat pump functioning



BOERI STEFANO
BOERI
ARCHITETTI



Stefano Boeri



DS+R



Elizabeth Diller



CZA

Cino Zucchi Architetti



Cino Zucchi



PLP/ARCHITECTURE



Lee Polisano



Pelli Clarke Pelli
Architects



Gregg Jones



**CARLO
RATTI
ASSOCIATI**



Carlo Ratti



AECOM



Christopher Choa

COIMA City Lab elaborates urban, product and project themes to inspire the development of cities and territories

Pilot Projects
150+ architects
have participated to beauty contests in the last 12 months

The social and cultural activities of the COIMA platform are mainly channelled through the Fondazione Riccardo Catella

OVERVIEW

- The Fondazione Riccardo Catella is the main body through which the social and cultural activities of the COIMA platform are channelled
 - Created in 2005 by Manfredi Catella, Founder and CEO of COIMA RES and President of the Foundation itself
 - Mission of spreading the culture of sustainability in land & district development and actively contributing to improving the quality of urban life through projects aimed at enhancing public spaces and green areas
- Civic-cultural projects to
 - involve and increase the sensitiveness of citizens about the importance of urban greenery
 - enhance the public areas of the city
 - promote the social inclusion of all its inhabitants
- Leading the Fondazione Riccardo Catella is a Board of Directors, assisted by a Scientific Committee with specialised skills

MAIN PROJECTS

BAM – BIBLIOTECA DEGLI ALBERI MILANO (SINCE 2018)

- Thanks to an innovative public private partnership between the Municipality of Milan and COIMA, the Fondazione Riccardo Catella is responsible for the management, safety, maintenance and cultural program of the public park Biblioteca degli Alberi
 - The park, designed by the Inside Outside studio of Petra Blaisse (Amsterdam)
 - Was created by the COIMA platform which, in June 2015, took over from the Municipality of Milan as part of the great urban project of Porta Nuova

PORTA NUOVA SMART CAMP (SINCE 2018)

- It is an inclusive and innovative project that brings together children with disabilities or serious and chronic diseases and healthy children in a common experience
 - Nature, sustainable architecture and technological innovation are the central themes of the Camp's activities, in conjunction with the values of the Fondazione Riccardo Catella and the Porta Nuova district

MICOLTIVO, ORTO A SCUOLA (SINCE 2012)

- Since 2012, the Fondazione Riccardo Catella, in collaboration with the Municipality of Milan and with the scientific support of the Department of Education Sciences of the University of Milan-Bicocca, has been promoting the MiColtivo program, Orto a Scuola
 - Aim of encouraging young generations to endorse a correct and healthy diet through the concrete experience of educational gardens installed in the courtyards of public city schools, providing for the redevelopment of these green spaces

DISCLAIMER



This presentation is not, and nothing in it should be construed as, an offer, invitation or recommendation in respect of any of the COIMA RES SpA SIIQ (the “**Company**”) securities, or an offer, invitation or recommendation to sell, or a solicitation of an offer to buy, any of the Company’s securities in any jurisdiction. Neither this presentation nor anything in it shall form the basis of any contract or commitment. This presentation is not intended to be relied upon as advice to shareholders, investors or potential investors and does not take into account the investment objectives, financial situation or needs of any investor. All investors should consider such factors in consultation with a professional advisor of their choosing when deciding if an investment is appropriate. The Company has prepared this presentation based on information available to it, including information derived from public sources that have not been independently verified. No representation or warranty, express or implied, is provided in relation to the fairness, accuracy, correctness, completeness or reliability of the information, opinions or conclusions expressed herein.

The financial information included in this presentation is unaudited.

All forward-looking statements attributable to the Company or persons acting on its behalf apply only as of the date of this document, and are expressly qualified in their entirety by the cautionary statements included elsewhere in this document. The financial projections are preliminary and subject to change; the Company undertakes no obligation to update or revise these forward-looking statements to reflect events or circumstances that arise after the date made or to reflect the occurrence of unanticipated events. Inevitably, some assumptions will not materialize, and unanticipated events and circumstances may affect the ultimate financial results. Projections are inherently subject to substantial and numerous uncertainties and to a wide variety of significant business, economic and competitive risks, and the assumptions underlying the projections may be inaccurate in any material respect. Therefore, the actual results achieved may vary significantly from the forecasts, and the variations may be material.

COIMA RES SpA SIIQ

Piazza Gae Aulenti, 12
20154 - Milano

Investor Relations – contact details
alberto.goretti@coimares.com | ir@coimares.com

www.coimares.com

